



The Innovators.® do it.®

1300 4 VATER



ELTRAK
SLIDING DOOR SYSTEMS



ELTRAK SLIDING DOOR SYSTEMS
-TRADE INFO GUIDE-

INFORMATION

SERIES
120

GRADUATE SERIES
Light Duty & Domestic
Max weight 120KG
34 high x 30 wide - 1mm
Ideal for garden sheds and garages

SERIES
200

DIRECTOR SERIES
Light Duty Industrial
Max weight 200KG
45 high x 35 wide - 1.2mm
Ideal for garages & small industrial sheds

SERIES
450

MATADOR SERIES
Medium Duty Industrial
Max weight 450KG
61 high x 50 wide - 1.55mm
Ideal for larger industrial & rural sheds

SERIES
650

HERCULES SERIES
Heavy Duty Industrial
Max weight 650KG
61 high x 50 wide - 1.6mm
Ideal for larger openings & heavy doors

COMMON
FIT

COMMON FITTINGS
Fits more than one weight rating system

BIFOLD
200

ROUND CORNER + BIFOLD
Max weight 200KG
Ideal for Bifold & Round Corner application

PAGE
4

BOTTOM ROLLER SLIDING DOOR
Ideal for larger openings & heavy doors
NOTE: Different Discount Structures Apply

PAGE
5

ACCESSORIES
Various accessories suitable for all series
NOTE: Different Discount Structures Apply



"The only carriages in the world designed to address wind load!"

EH16STHD

•Patent •Registered Design



TRACK

DOOR TRACK

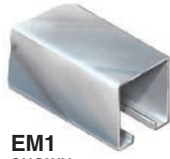

CUSTOM ROLLED FOR YOUR CONVENIENCE!

EM1 SHOWN	GALVANISED		
	UNIT	PK	KG per M
EG2	METRE	60	0.88
ED2	METRE	60	1.26
EM1	METRE	40	2.47
EH1	METRE	40	2.53

NEW!

EM1SS	STAINLESS STEEL	
	UNIT	KG per 3M
3M LGTH		7.80

CURVED SECTION



600MM RADIUS CURVE

ED2600R	GALVANISED		
	UNIT	PK	KG per M
EA	20		2.02
EH1600R	EA	20	3.96

TRACK JOINING BRACKET



LOCKING ADJUSTMENT SCREWS INCLUDED

EDJB SHOWN	GALVANISED		
	UNIT	CTN	KG
EDJB	EA	60	0.25
EHJB	EA	40	0.32

TRACK END STOP - MULTI FIT



ZINC PLATED

EC40	ZINC PLATED		
	UNIT	CTN	KG
EA	150		0.05

TRACK END PLATE



EH30 SHOWN	GALVANISED		
	UNIT	CTN	KG
ED30	EA	200	0.02
EH30	EA	200	0.03

TOP PLATE & ADJUSTING NUT



ZINC PASSIVATE

ED37	ZINC PASSIVATE		
	UNIT	CTN	KG
EA	100		0.07
EM37	EA	100	0.13
EH37	EA	100	0.13

CARRIAGES

•Patent •Registered Design



• LONG SWIVEL PIN
• BALL BEARING RACE
• SMOOTH SILENT OPERATION
• 2 PER DOOR REQUIRED

EG7 SHOWN	NYLON TYRES		
	UNIT	CTN	KG
EG7	EA	100	0.12
ED7LP	EA	100	0.15
EH7	EA	50	0.36

•Patent •Registered Design



• CAPTURED LOOSE PIN
• SMOOTH SILENT OPERATION
• 2 PER DOOR REQUIRED

EG14LP SHOWN	NYLON TYRES		
	UNIT	CTN	KG
EG14LP	EA	80	0.24
ED14LP	EA	80	0.27
EH13LP	EA	20	0.68

FOUR WHEEL - NYLON SWIVEL

•Patent •Registered Design



• FULL INDEPENDENT SWIVEL BODY
• BALL BEARING RACE
• SMOOTH SILENT OPERATION
• 2 PER DOOR REQUIRED

EH14LP SHOWN	NYLON TYRES		
	UNIT	CTN	KG
EH14LP	EA	20	0.74

FOUR WHEEL - STEEL

•Patent •Registered Design



• HD NEEDLE BEARING
• CAPTURED LOOSE PIN
• HARDENED THRUST CAPS
• 2 PER DOOR REQUIRED

EG12 SHOWN	STEEL WHEELS		
	UNIT	CTN	KG
EG12	EA	100	0.22
ED12LP	EA	80	0.31
EH12LP	EA	30	0.71

SIDE THRUST - STEEL

•Patent •Registered Design



• HD NEEDLE BEARING
• CAPTURED LOOSE PIN
• HARDENED THRUST CAPS
• 2 PER DOOR REQUIRED

EH12ST SHOWN	STEEL WHEELS		
	UNIT	CTN	KG
EH12ST	EA	30	0.76
EH15ST	EA*	30	0.82
*500kg max			

SIDE THRUST - STEEL

•Patent •Registered Design



• FULL INDEPENDENT SWIVEL BODY
• HD BALL BEARING RACE
• 2 PER DOOR REQUIRED

EH16STHD SHOWN	STEEL OR POLYMER WHEELS		
	UNIT	CTN	KG
EH16ST	EA -STEEL	20	1.10
EH16STHD	EA* -POLYMER	18	1.01
*850kg max			

BRACKETS

COMBINATION BRACKETS
• BOLT ON • WELD ON • SIDE FIX
• Patent • Registered Design

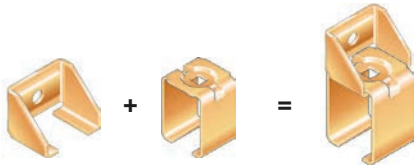

WELD / BOLT ON SINGLE
• Patent • Registered Design

EH19 SHOWN	ZINC PASSIVATE		
	UNIT	CTN	KG
EG19	EA	150	0.08
ED19	EA	140	0.15
EH19	EA	50	0.24

BOLT ON FLUSH FIX BRACKET ADAPTOR
• Patent • Registered Design

ED / EH120 SHOWN	ZINC PASSIVATE		
	UNIT	CTN	KG
ED120	EA	140	0.08
EH120	EA	100	0.13

COMBINATION BRACKET
• Patent • Registered Design

EH20G	HOT DIPPED GALVANISED		
	UNIT	CTN	KG
EH20G	EA	20	0.42

BOLT SET WITH NUT & WASHER

EG64BS ED19BS EH19BS	ZINC PASSIVATE		
	UNIT	CTN	KG
EG64BS	EA	120	0.02
ED19BS	EA	140	0.02
EH19BS	EA	200	0.08

SINGLE SIDE FIX - STEPPED

ED20C SHOWN	ZINC PASSIVATE		
	UNIT	CTN	KG
GAR1/35	EA	100	0.18
EG20	EA	100	0.15
ED20A	EA	60	0.29
ED20B	EA	60	0.29
ED20C	EA	50	0.34
EH20C	EA	20	0.61

DOUBLE OVERHEAD

EG22 EG22A	ZINC PASSIVATE		
	UNIT	CTN	KG
EG22	EA	60	0.19
EG22A	EA	60	0.28

EH22 SHOWN	ZINC PASSIVATE		
	UNIT	CTN	KG
ED22A	EA	30	0.19
ED22B	EA	30	0.28
ED22C	EA	30	0.41
EH22	EA	30	0.79

SINGLE SIDEFIX SUPPORT

EG23 SHOWN	ZINC PASSIVATE		
	UNIT	CTN	KG
EG23	EA	150	0.06
ED23	EA*	80	0.14
EH23	EA*	50	0.36

*BOLT SET NOT INCLUDED

DOUBLE SIDEFIX SUPPORT
• Patent • Registered Design

ED25 SHOWN	ZINC PASSIVATE		
	UNIT	CTN	KG
ED24	EA	30	0.43
ED25	EA	30	0.38
EH24	EA	20	0.67

SINGLE OVERHEAD CAVITY

EH26 SHOWN	ZINC PASSIVATE		
	UNIT	CTN	KG
ED26	EA	80	0.25
EH26	EA	40	0.37

DOUBLE SUPPORT - WELD

ED27 SHOWN	ZINC PASSIVATE		
	UNIT	CTN	KG
ED27	EA	60	0.25
EH27B	EA	50	0.37

DOUBLE SUPPORT - 300KG

EH28 EH28BP	ZINC PASSIVATE		
	UNIT	CTN	KG
EH28	EA	20	0.60
EH28BP	EA*	50	0.39

*BACK PLATE

DOUBLE SUPPORT - BOLT

EH44	ZINC PASSIVATE		
	UNIT	CTN	KG
EH44	EA	25	0.48

FLASHING - ADJUSTABLE

EC50	ZINC PASSIVATE		
	UNIT	CTN	KG
EC50	EA	60	0.17

DOUBLE SUPPORT

EG64 ED64 ED64C	ZINC PASSIVATE		
	UNIT	CTN	KG
EG64	EA	60	0.17
ED64	EA	60	0.30
ED64C	EA	60	0.35

DOUBLE CENTRE SIDEFIX

ED68 SHOWN	ZINC PASSIVATE		
	UNIT	CTN	KG
EG68	EA	50	0.37
ED68	EA	30	0.52
ED68B	EA	30	0.52

DOOR FRAMING SYSTEM
• Patent • Registered Design

EF4 EF4S	CUSTOM ROLLED FOR YOUR CONVENIENCE! GALVANISED		
	UNIT	PK	KG per M
EF4	METRE	40	1.92
EF4S	METRE	40	1.92

DOOR FRAME BACKING RAILS
• Patent • Registered Design

EB2	CUSTOM ROLLED FOR YOUR CONVENIENCE! GALVANISED		
	UNIT	PK	KG per M
EB2	METRE	40	1.54

CORNER BRACE
• Patent • Registered Design

EFC	GALVANISED		
	UNIT	CTN	KG
EFC	EA	50	0.21

TEE JOIN BRACE
• Patent • Registered Design

EFT	GALVANISED		
	UNIT	CTN	KG
EFT	EA	50	0.21

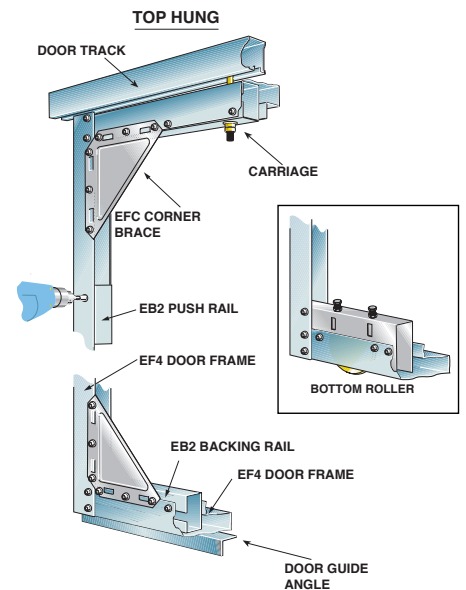

GUIDES

DOUBLE IN GROUND GUIDE

•Patent •Registered Design



		GALVANISED	
UNIT	CTN	CTN	KG
EHDIGG	EA	40	0.30

NYLON FLOOR PAD

•Patent •Registered Design



		NYLON	
UNIT	CTN	CTN	KG
ECFGP	EA	40	0.18

GUIDE ANGLES



		GALVANISED	
UNIT	PK	CTN	KG per M
ECFGAM	METRE	40	2.17

GUIDE PADS



		NYLON	
UNIT	CTN	CTN	KG
EC6P	PACK*	50	0.02
*Contains 4 x pads - 8 x pop rivets			

Bottom Roller Sliding Door Systems

TRACK

INGROUND TRACK



		GALVANISED	
LENGTH		CTN	KG
OMEGA Z3	3 METRE		13.0
OMEGA Z5.8	5.8 METRE		25.5

ABOVE GROUND

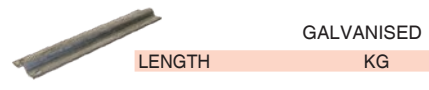

		GALVANISED	
LENGTH		CTN	KG
FLOOR Z3	3 METRE		5.0
FLOOR Z5.8	5.8 METRE		10.0
FLOOR V3	3 METRE		4.5
FLOOR V5.8	5.8 METRE		8.5

TRACK JOINER



		ZINC PASSIVATE	
UNIT	CTN	CTN	KG
TJZ	EA	20	0.10
Suits Omega Track			

TOP GUIDE ROLLER

•Patent •Registered Design



		ZINC PASSIVATE	
RATING	CTN	CTN	KG
EH16TG	350kg	20	0.38

BOTTOM ROLLER ONLY

DB = DOUBLE BEARING

END NUMBER IS DIAMETER OF WHEEL

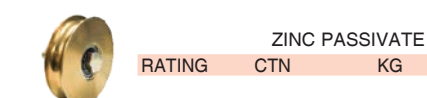

		ZINC PASSIVATE		
	RATING	CTN	CTN	KG
DB-CU120	Roller Only 250kg	8		2.23
DB-CU160	500kg	6		4.05



		ZINC PASSIVATE		
	RATING	CTN	CTN	KG
DB-AU100	Welded Support 400kg	10		1.13

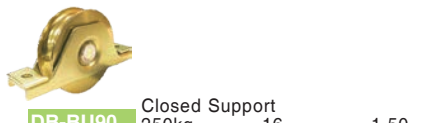

		ZINC PASSIVATE		
	RATING	CTN	CTN	KG
DB-BU90	Closed Support 250kg	16		1.50

ROLLER CASSETTE

•Patent •Registered Design

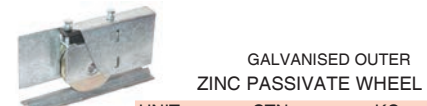

		GALVANISED OUTER ZINC PASSIVATE WHEEL		
UNIT	CTN	CTN	CTN	KG
ECBRA350	EA	4		3.80

Round Corner & Bifold Door Systems

TRACK

STANDARD TRACK

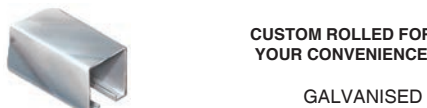

		CUSTOM ROLLED FOR YOUR CONVENIENCE!		
		GALVANISED		
UNIT	CTN	CTN	CTN	KG per M
EM1	METRE	40		2.47

BOTTOM CURVED SECTION

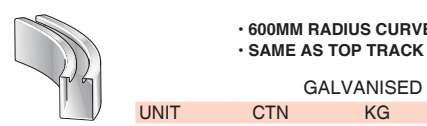

- 600MM RADIUS CURVE
- SAME AS TOP TRACK

		GALVANISED		
UNIT	CTN	CTN	CTN	KG
EH1600R	EA	20		2.79

TRACK JOINING BRACKET

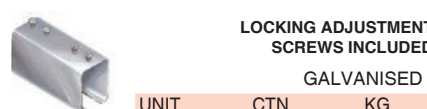

		LOCKING ADJUSTMENT SCREWS INCLUDED		
		GALVANISED		
UNIT	CTN	CTN	CTN	KG
EHJB	EA	40		0.32

CARRIAGES

TWO WHEEL

•Patent •Registered Design

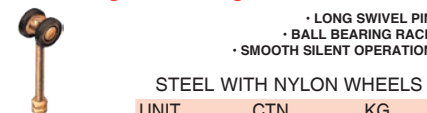

- LONG SWIVEL PIN
- BALL BEARING RACE
- SMOOTH SILENT OPERATION

		STEEL WITH NYLON WHEELS		
UNIT	CTN	CTN	CTN	KG
EH7	EA	50		0.36

FOUR WHEEL

•Patent •Registered Design

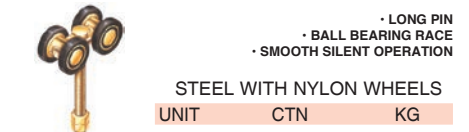

- LONG PIN
- BALL BEARING RACE
- SMOOTH SILENT OPERATION

		STEEL WITH NYLON WHEELS		
UNIT	CTN	CTN	CTN	KG
EH14M	EA	20		0.64

WITH SINGLE HINGE

•Patent •Registered Design

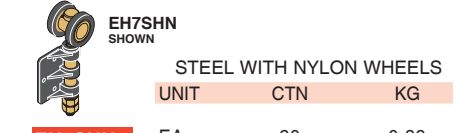

		STEEL WITH NYLON WHEELS		
UNIT	CTN	CTN	CTN	KG
EH7SHN	EA	20		0.39
EH14SHN	EA	20		0.68

WITH DOUBLE HINGE

•Patent •Registered Design

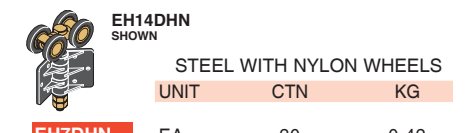

		STEEL WITH NYLON WHEELS		
UNIT	CTN	CTN	CTN	KG
EH7DHN	EA	20		0.42
EH14DHN	EA	20		0.71

HINGES

SPRING LOADED SINGLE HINGE

•Patent •Registered Design

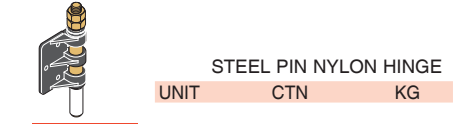

		STEEL PIN NYLON HINGE		
UNIT	CTN	CTN	CTN	KG
EH6RBSHN	EA	40		0.20

SPRING LOADED DOUBLE HINGE

•Patent •Registered Design

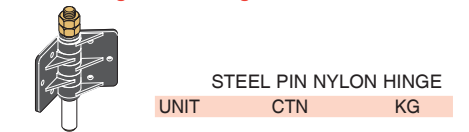

		STEEL PIN NYLON HINGE		
UNIT	CTN	CTN	CTN	KG
EH6RBDHN	EA	40		0.23

NYLON HINGE

•Patent •Registered Design



		NYLON PIN		
UNIT	CTN	CTN	CTN	KG
EH62N	EA	40		0.08

HINGE HANDLE

•Patent •Registered Design

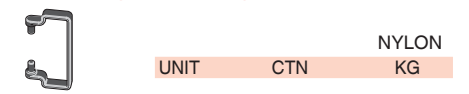

		NYLON		
UNIT	CTN	CTN	CTN	KG
EH62NHANDLE	EA	40		0.03

NYLON GUIDE PIN ONLY

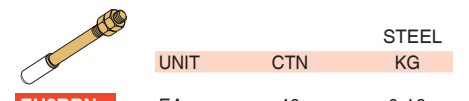

		STEEL		
UNIT	CTN	CTN	CTN	KG
EH6RBN	EA	40		0.16

LOCKS & STOPS

FLUSH FITTED LOCKS

•Patent •Registered Design

EFFLK

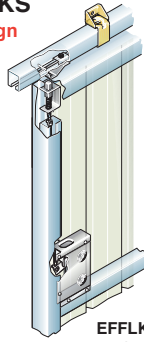
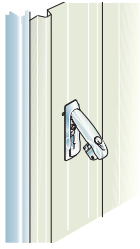

EFFLK
BACK VIEW

		GALVANISED	
	UNIT	CTN	KG
EDLK	EA	10	0.49
EDLKT	EA	10	0.82
EFFLK	EA*	4	2.12
EFFLK50SQ	EA*	4	2.12

*FLUSH

PAD BOLTS

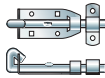

		ZINC	
	UNIT	CTN	KG
EPB100	EA	50	0.10
EPB150	EA	30	0.36

LOCKABLE DROP BOLT



		ZINC	
	UNIT	CTN	KG
DBP40012L	EA	40	0.55
DB45020	EA	20	1.32

D TYPE HANDLES

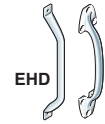

		GALV / CHROME	
	UNIT	CTN	KG
EHD	EA	30	0.19
ELD	EA	30	0.15

TEE HANDLE KIT



		ZINC	
	UNIT	CTN	KG
ETHK	EA	30	0.21

INSIDE LATCH

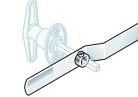

		ZINC	
	UNIT	CTN	KG
ELH	EA	60	0.13

HASP & STAPLE

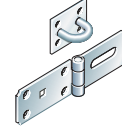

		ZINC	
	UNIT	CTN	KG
EHS	EA	30	0.43

ACCESSORIES

TRAVEL STOP

For use with bottom roller applications

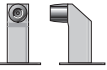

		GALVANISED	
	UNIT	CTN	KG
WTS	EA	10	0.60
FMTS	EA	10	0.93
MX04B	EA*	20	0.90

*ZINC PASSIVATE

BARN DOOR KITS



INCLUDES:
- 2M TRACK
- 2 X ROLLERS
- FIXINGS
- FLOOR GUIDES



		PCB	
	KITS	CTN	KG
BDH01	SIDE FIX	1	6.00
BDH03	OVERHEAD	1	6.00

METAL PIN ANCHORS



		GALVANISED	
	UNIT	CTN	CTN KG
SDA6532	EA	100	1.00
SDA6540	EA	100	1.10
SDA6550	EA	100	1.38

MUSHROOM HEAD ANCHOR



		GALVANISED	
	UNIT	CTN	CTN KG
MH6538	EA	100	1.89
MH6575	EA	100	2.02

WAFER HEAD TEK SCREW



		GALVANISED	
	UNIT	CTN	CTN KG
VWTEK101616G	EA	1000	1.18

FLUSH FIX HINGE



		STAINLESS STEEL	
	UNIT	CTN	CTN KG
FFH10075SS	EA	20PR	9.00

BUTT HINGES



		ZINC PLATED	
	UNIT	CTN	CTN KG
BH10075FPSS	EA*	40PR	17.0
	FIXED PIN - *STAINLESS STEEL		
BH10075FP	EA	40PR	17.0
	FIXED PIN		
BH10075LP	EA	40PR	17.0
	LOOSE PIN		

CURTAIN HANGER BRACKET



		ZINC PASSIVATE	
	UNIT	CTN	KG
ED7MBRK	EA	200	0.02

Bracket Spacing Guide

Calculate the correct support bracket spacings according to door weight on the chart below

WARNING: Incorrect bracket spacing or insufficient number of support brackets may cause premature component wear and poor operation of your sliding door system.

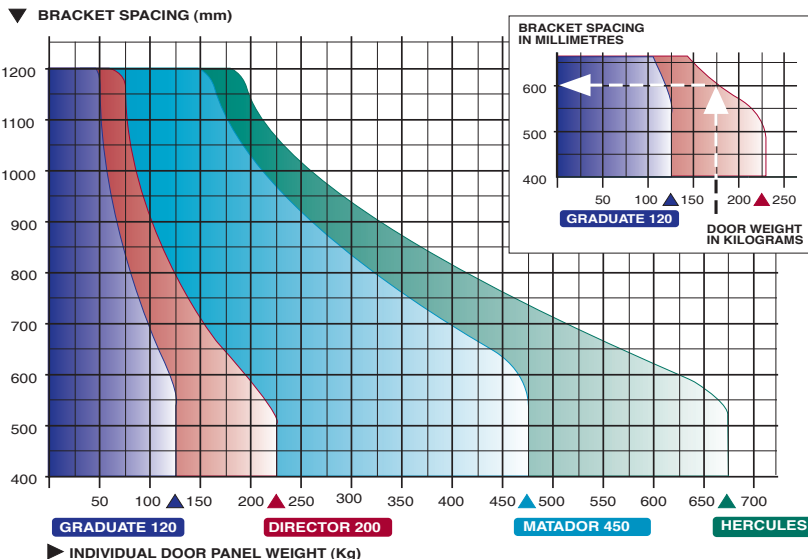



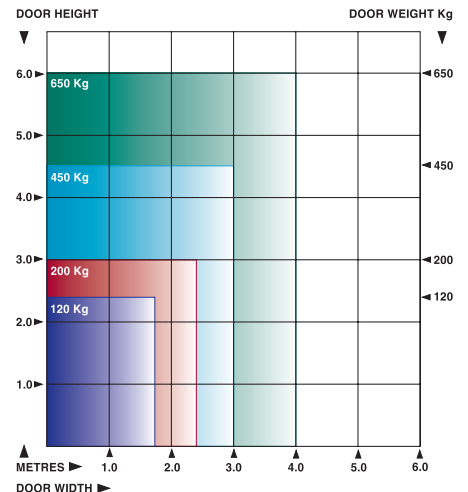











Max Door Panel Sizes



CATALOGUE RANGE

WWW.VATERHARDWARE.COM

	ELTRAK SLIDING DOOR SYSTEMS CATALOGUE	30pg
	ELTRAK TOP HUNG DOOR SYSTEMS	16pg
	ELTRAK BOTTOM ROLLER DOOR SYSTEMS	12pg
	ELTRAK SLIDING DOOR SYSTEMS PRICE LIST	6pg
	ELGATE SECURITY FENCE & GATE SYSTEMS CATALOGUE	48pg
	ELGATE FENCE & GATE SYSTEMS PRICE LIST	6pg
	ELGATE RURAL FARM & GATE SYSTEMS	6pg
	ELGATE SLIDING GATE HARDWARE	6pg
	VATER SAFETY RAIL & BARRIER FITTINGS	6pg
	VATER GATE AUTOMATION SYSTEMS	6pg
	VATER CANTILEVER GATE SYSTEMS	6pg
	VATER HARDWARE & ACCESSORIES	6pg
	VATER D&D POOL LOCKS & GATE HARDWARE	44pg
	WATCH THIS SPACE! EXCITING NEW PRODUCT RELEASES!	

ADELAIDE

Vater Hardware
28-32 Morgan Street
Wingfield, SA 5013
Tel: +61 8 8268 3511
Fax: +61 8 8445 7470
adelaide@vaterhardware.com

SYDNEY

Vater Hardware
2/78 Heathcote Road
Moorebank, NSW 2170
Tel: +61 2 8777 0777
Fax: +61 2 8777 0778
sydney@vaterhardware.com

BRISBANE

Vater Hardware
2/388 Newman Road
Geebung, QLD 4034
Tel: +61 7 3265 7888
Fax: +61 7 3265 7688
brisbane@vaterhardware.com

MELBOURNE

Vater Hardware
18-24 Pelson Court
Dandenong Sth, VIC 3175
Tel: +61 3 8902 8800
Fax: +61 3 8902 8898
melbourne@vaterhardware.com

PERTH

Vater Hardware
56 O'Malley Street
Osborne Park, WA 6017
Tel: +61 8 9492 8444
Fax: +61 8 9244 5635
perth@vaterhardware.com