

Third Edition

Hot Rolled and Structural Steel Products

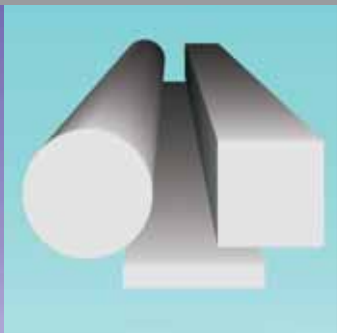

HOT ROLLED AND STRUCTURAL STEEL PRODUCTS

CONTENTS

Introduction	2
Availability	
Structural Steel Sections	2
Rail Products	4
Merchant Bar Sections	6
Dimensions and Design Information	
Welded Beams	8
Welded Columns	10
Universal Beams	12
Universal Columns	14
Tapered Flange Beams	16
Parallel Flange Channels	17
Universal Bearing Piles	18
Equal Angles	19
Unequal Angles	22
Rails	25
Standard Specifications	
Structural Steel Sections	26
Rail Products	28
Merchant Bar Sections	28
Customer Technical Service	30

INTRODUCTION

OneSteel is Australia's premier long products steel company and is comprised of three Australian business groups.

- OneSteel Market Mills
- OneSteel Distribution
- OneSteel Whyalla Steelworks

This booklet is produced by OneSteel Market Mills and is intended to provide general information on a range of hot rolled and structural steel products. The following text will refer to OneSteel Market Mills as OneSteel.

AVAILABILITY

Structural Steel Sections

Hot Rolled Products

Hot Rolled Structural Steel sections produced by OneSteel are manufactured in accordance with the requirements of Australian Standard AS/NZS 3679.1:1996 Structural Steel - Hot Rolled Bars and Sections.

Grade Availability

300PLUS[®] Steel is the standard grade manufactured by OneSteel for hot rolled Structural Steel Sections.

300PLUS[®] Steel for hot rolled products is produced to exceed the minimum requirements of AS/NZS 3679.1:1996 grade 300.

Other grades including 300PLUSL0, AS/NZS 3679.1-350 and AS/NZS 3679.1-350L0 may also be available depending on the section and quantity required. For further information contact your nearest OneSteel Sales Office (Contact details on page 30).

Length Availability

The majority of Structural Steel Sections produced by OneSteel are available in standard length and bundle configurations. We would recommend that attention be given to the standard lengths produced by OneSteel as they are more readily available than other lengths. Table 1 indicates the standard lengths produced by OneSteel in Structural Steel Sections. For other lengths (including those in excess of 18 metres) please contact your nearest OneSteel Sales Office for further details (Contact details on page 30).

Welded Products

OneSteel Market Mills also markets a range of large Welded Product Structural Steel sections. These sections are welded from plate and are manufactured in accordance with Australian Standard AS/NZS 3679.2:1996 Structural Steel - Welded I Sections.

Grade Availability

300PLUS[®] Steel is the standard grade manufactured for Welded Products. 300PLUS[®] welded products are produced to exceed the minimum requirements of AS/NZS 3679.2:1996 grade 300.

A higher grade option of AS/NZS 3679.2:1996 grade 400 is also available.

Other grades are subject to enquiry and this should be directed to your nearest OneSteel Sales Office.

Length Availability

Lengths are available from a minimum of 6 metres to a maximum of 30 metres. Table 1 indicates the standard lengths produced.



Table 1 Standard Lengths

Section	Length (m)	7.5	9.0	10.5	12.0	13.5	15.0	16.5	18.0	20.0*
Welded Sections										
1200 WB, 1000 WB, 900 WB, 800 WB, 700 WB			•	•	•	•	•	•	•	•
500 WC, 400 WC, 350 WC			•	•	•	•	•	•	•	•
Universal Beams										
610 UB, 530 UB, 460 UB, 410 UB, 360 UB			•	•	•	•	•	•	•	•
310 UB 46.2, 40.4			•	•	•	•	•	•	•	•
310 UB 32.0			•	•	•	•	•	•	•	•
250 UB			•	•	•	•	•	•	•	•
200 UB 29.8, 25.4, 22.3			•	•	•	•	•	•	•	•
200 UB 18.2			•	•	•	•	•	•	•	•
180 UB, 150 UB			•	•	•	•	•	•	•	•
Universal Columns										
310 UC 158, 137, 118			•	•	•	•	•	•	•	•
310 UC 96.8			•	•	•	•	•	•	•	•
250 UC			•	•	•	•	•	•	•	•
200 UC, 150 UC			•	•	•	•	•	•	•	•
100 UC			•	•	•	•	•	•	•	•
Taper Flange Beams										
125 TFB, 100 TFB			•	•	•	•	•	•	•	•
Parallel Flange Channels										
380 PFC, 300 PFC			•	•	•	•	•	•	•	•
250 PFC			•	•	•	•	•	•	•	•
230 PFC, 200 PFC, 180 PFC, 150 PFC			•	•	•	•	•	•	•	•
125 PFC, 100 PFC, 75 PFC			•	•	•	•	•	•	•	•
Equal Angles										
200 EA, 150 EA, 125 EA			•	•	•	•	•	•	•	•
100 EA, 90 EA, 75 EA			•	•	•	•	•	•	•	•
65 EA, 55 EA, 50 EA, 45 EA, 40 EA **			•	•	•	•	•	•	•	•
30 EA, 25 EA			•	•	•	•	•	•	•	•
Unequal Angles										
150 x 100 UA, 150 x 90 UA			•	•	•	•	•	•	•	•
125 x 75 UA, 100 x 75 UA			•	•	•	•	•	•	•	•
75 x 50 UA			•	•	•	•	•	•	•	•
65 x 50 UA			•	•	•	•	•	•	•	•

• The Section/Length combination is available in Standard Bundle configurations.

* By enquiry - Delivery to Capital cities only.

** Certain thicknesses may not be available in both lengths, confirm availability with a OneSteel Market Mills Sales Office

Rail Products

Rails

The majority of rails manufactured by OneSteel in Whyalla are produced to AS 1085.1 Railway Track Material Part 1 — Steel Rails.

Table 38 page 28 lists the various rail sections produced at Whyalla together with the conforming standard.

For dimensional details see Table 31 page 25.

Length — standard length available for AS68kg rail is 25m, for all other rails standard lengths are 12.19 m, 13.72 m and 27.5 m.

Drilling — rails can be supplied drilled or undrilled.

Head Hardened Rails

Where rail wear, plastic flow of the rail head, corrugation or rail fatigue defects are reducing rail life it is recommended that OneSteel head hardened rail be specified. Available test data indicate a doubling of rail life will occur. Head hardened rail is available in 50 kg/m, 60 kg/m and 68 kg/m sizes.

Some situations where heavier and more expensive crane rail is specified can also be handled with high strength head hardened rail.

For further information on rail products contact:

Rail Sales & Marketing Office - OneSteel Whyalla Steelworks

(Refer to Page 30)

Depth of heat treatment and hardness gradient as per AS 1085.1-2002

Dimensions (mm) a. 15 Min. 23 Max.

Dimensions (mm) b. 20 Min. 35 Max. for 50 kg Rail

Dimensions (mm) b. 25 Min. 40 Max. for 60 kg and 68 kg Rail

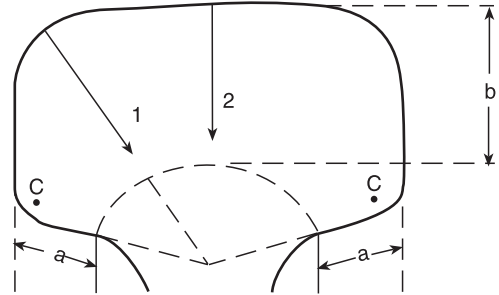

**Table 2 Hardness Limits
(Vickers Diamond Pyramid Numeral)**

Location	Hardness HV30
Position C	430 Max.
Along Transverse 1	430 Max. at any point. 360 Min. at 10 mm from rail surface.
Along Transverse 2	430 Max. at any point. 340 Min. at 10 mm from rail surface.

Chemical Composition

The steel is produced by the basic oxygen method, continuously cast. The steel cast analysis is within the limits shown in Table 38 Page 28

Steel Sleeper Sections

OneSteel produces rolled sections at the Whyalla Works which are used in the manufacture of steel sleepers.

The mainline “M” section is available in a range of thicknesses varying from 6.5 mm to 10 mm. These steel sleeper sections may be used for turnout bearers.

Details of these sections may be obtained from the Rail Sales & Marketing Office (Refer to Page 30).

Table 3 Mainline Sleepers

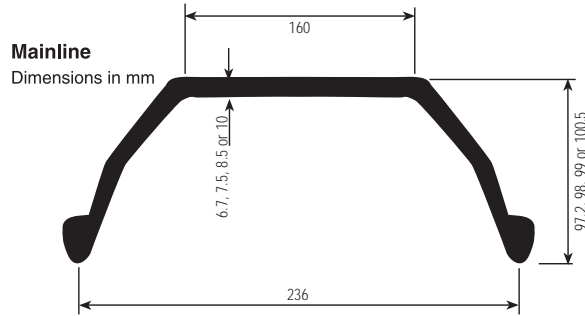

Designation	Mass kg/m	Web Thickness mm
M10	26.2	10.0
M8.5	23.1	8.5
M7.5	21.1	7.5
M6.5	19.5	6.7



Merchant Bar Sections

Rounds, Squares, Flats and Hexagons

Availability

Merchant bar rounds, squares, flats and hexagons are available in a variety of steel grades and sizes.

Due to process limitations not all grades are available in all sizes. For new applications we recommend you confirm product availability with a OneSteel Sales Office at an early stage of design. Other specifications and sizes may also be available on enquiry.

Specifications

Merchant bar sections are available in the following standards:

- 300PLUS® and AS/NZS 3679.1
Structural Steel-Hot Rolled Bars and Sections.
- AS 1442
Carbon Steels and Carbon Manganese Steels-Hot Rolled Bars and Semifinished Products.
- AS 1444
Wrought Alloy Steels Standard, Hardenability (H) Series and Hardened and Tempered to Designated Mechanical Properties.
- AS 1447
Hot-Rolled Spring Steels.
- OneSteel grades
(based on AISI-SAE nomenclature).

Table 4 Rounds — Size Availability and Mass

Diameter (mm)	Mass (kg/m)
10	0.616
12	0.887
13	1.04
14	1.21
15	1.39
16	1.58
17	1.78
18	1.99
19	2.23
20	2.46
21	2.72
22	2.98
24	3.55
26	4.17
27	4.49
30	5.55
32	6.31
33	6.71
36	7.99
39	9.38
42	10.9
45	12.5
48	14.2
50	15.4
56	19.3
60	22.2
65	26.0
75	34.7
80	39.5
90	49.9

Standard Length: 6 Metres

Table 5 Squares — Size Availability and Mass

Thickness (mm)	Mass (kg/m)
10*	0.790
12	1.13
16	2.01
20	3.14
25	4.91
40	12.5

Standard Length: 6 Metres

* Confirm availability with sales office.

Table 6 Hexagons — Size Availability and Mass

Size (mm)	Mass (kg/m)
20	2.72
25	4.25
30	6.12
37.5	9.56
39.5	10.6
44	13.2
47.5	15.3
49	16.3
53.5	19.5
57.5	22.5
63	27.0

Standard Length: 6 Metres

Table 7 Flats — Size Availability and Mass (kg/m)

Width (mm)	Thickness (mm)									
	5	6	8	10	12	16	20	25	40	50
20				1.57						
25	0.981	1.18	1.57	1.96	2.36					
32	1.26	1.51	2.01	2.51	3.01					
40	1.57	1.88	2.51	3.14	3.77	5.02	6.28			
50	1.96	2.36	3.14	3.93	4.71	6.28	7.85	9.81		
65	2.55	3.06	4.08	5.10	6.12	8.16	10.2			
75	2.94	3.53	4.71	5.89	7.07	9.42	11.8	14.7	23.6	
90		4.24	5.65	7.07	8.48					
100	3.93	4.71	6.28	7.85	9.42	12.6	15.7	19.6		39.3
110		5.18	6.91	8.64	10.4					
130	5.10	6.12	8.16	10.2	12.2	16.3	20.4	25.5		
150	5.89	7.07	9.42	11.8	14.1	18.8	23.6	29.4		58.9
180		8.48	11.1	14.1	17.0		28.3			
200		9.42	12.6	15.7	18.8	25.1	31.4	39.3		
250		11.8	15.7	19.6	23.6					
300		14.1	18.8	23.6	28.3					

Standard Length: 6 Metres

Table 8 Merchant Bar Sections - Regular Grades

Steel Type	Standard	Grades Available
Structural Steels	OneSteel	300PLUS
	AS/NZS 3679.1	350
Carbon and Carbon-Manganese Steels	AS 1442	U1008
		U1010
		1016
		U1021
		1022
		1030
		X1038
		1040
		U1040
		1045
		U1045
		1055
		1070
		U1070
10M40		
X1320		
X1340		
Mechanically Tested	AS 1442	U3
		U5
		U6
		9
Merchant Quality Steels	AS 1442	M1020
		M1030
Free Cutting Steels	AS 1442	1137
		1146
		X1147
		1214
Alloy Steels	AS 1444	5155
		5160
		9255
		9261
Spring Steels	AS 1447	XK5155S
		XK5160S
		XK9258S
		XK9261S
OneSteel Grades	OneSteel	U1004
		1015
		1082
		X4K92M61S

Rods and Light Billets

Rods and light billets are available in a wide range of OneSteel grades, and selected grades from AS 1442, AS 1444 and AS 1447 specifications.

These sections are not available in structural grades 300PLUS® and 350.

Due to process limitations not all grades are available in all sizes. Confirm product availability with a OneSteel Sales Office at an early stage of design.

**Table 10
Light Billets Size Availability**

Sizes Available mm x mm
45 x 45
50x 50
63 x 63
75 x 75

Table 9 Rods Size Availability

Diameter (mm)
5.5 6.5 7.0 8.0 9.0 10.0 11.2 12.5 13.0 14.0 15.0 16.0 17.0 18.0

Welded Beams

Table 11 Welded Beams — Dimensions and Properties

Designation	Depth of Section d	Flange		Web Thickness t_w	Depth Between Flanges d_1	$(b_f - t_w)$		Gross Area of Cross-Section A_g	About x-axis				About y-axis				Torsion Constant J	Warping Constant I_w	Designation
		Width b_f	Thickness t_f			d_1	$2t_f$		I_x	Z_x	S_x	r_x	I_y	Z_y	S_y	r_y			
kg/m	mm	mm	mm	mm	mm	mm	mm	mm ²	10 ⁶ mm ⁴	10 ³ mm ³	10 ³ mm ³	mm	10 ⁶ mm ⁴	10 ³ mm ³	10 ³ mm ³	mm	10 ³ mm ⁴	10 ⁹ mm ⁶	
1200 WB 455	1200	500	40	16	1120	70.0	6.05	57900	15300	25600	28200	515	834	3330	5070	120	22000	280000	1200 WB 455
423	1192	500	36	16	1120	70.0	6.72	53900	13900	23300	25800	508	750	3000	4570	118	16500	251000	423
392	1184	500	32	16	1120	70.0	7.56	49900	12500	21100	23400	500	667	2670	4070	116	12100	221000	392
342	1184	400	32	16	1120	70.0	6.00	43500	10400	17500	19800	488	342	1710	2630	88.6	9960	113000	342
317	1176	400	28	16	1120	70.0	6.86	40300	9250	15700	17900	479	299	1500	2310	86.1	7230	98500	317
278	1170	350	25	16	1120	70.0	6.68	35400	7610	13000	15000	464	179	1020	1600	71.1	5090	58700	278
249	1170	275	25	16	1120	70.0	5.18	31700	6380	10900	12900	449	87.0	633	1020	52.4	4310	28500	249
1000 WB 322	1024	400	32	16	960	60.0	6.00	41000	7480	14600	16400	427	342	1710	2620	91.3	9740	84100	1000 WB 322
296	1016	400	28	16	960	60.0	6.86	37800	6650	13100	14800	420	299	1490	2300	89.0	7010	73000	296
258	1010	350	25	16	960	60.0	6.68	32900	5430	10700	12300	406	179	1020	1590	73.8	4870	43400	258
215	1000	300	20	16	960	60.0	7.10	27400	4060	8120	9570	385	90.3	602	961	57.5	2890	21700	215
900 WB 282	924	400	32	12	860	71.7	6.06	35900	5730	12400	13600	399	341	1710	2590	97.5	8870	67900	900 WB 282
257	916	400	28	12	860	71.7	6.93	32700	5050	11000	12200	393	299	1490	2270	95.6	6150	58900	257
218	910	350	25	12	860	71.7	6.76	27800	4060	8930	9960	382	179	1020	1560	80.2	4020	35000	218
175	900	300	20	12	860	71.7	7.20	22300	2960	6580	7500	364	90.1	601	931	63.5	2060	17400	175
800 WB 192	816	300	28	10	760	76.0	5.18	24400	2970	7290	8060	349	126	840	1280	71.9	4420	19600	800 WB 192
168	810	275	25	10	760	76.0	5.30	21400	2480	6140	6840	341	86.7	631	964	63.7	2990	13400	168
146	800	275	20	10	760	76.0	6.63	18600	2040	5100	5730	331	69.4	505	775	61.1	1670	10600	146
122	792	250	16	10	760	76.0	7.50	15600	1570	3970	4550	317	41.7	334	519	51.7	921	6280	122
700 WB 173	716	275	28	10	660	66.0	4.73	22000	2060	5760	6390	306	97.1	706	1080	66.4	4020	11500	700 WB 173
150	710	250	25	10	660	66.0	4.80	19100	1710	4810	5370	299	65.2	521	798	58.4	2690	7640	150
130	700	250	20	10	660	66.0	6.00	16600	1400	3990	4490	290	52.1	417	642	56.0	1510	6030	130
115	692	250	16	10	660	66.0	7.50	14600	1150	3330	3790	281	41.7	334	516	53.5	888	4770	115

Notes

1. All welds to AS/NZS 1554.1 Category SP (deep penetration).
2. Web to flange joints develop the minimum tensile strength of the web.
3. Flame cut surfaces not incorporated in welds have a minimum surface roughness of class 2, as defined in WTIA Technical Note 5.

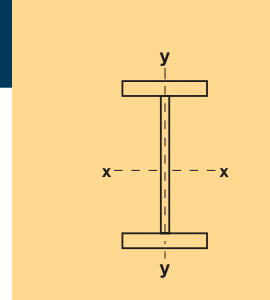
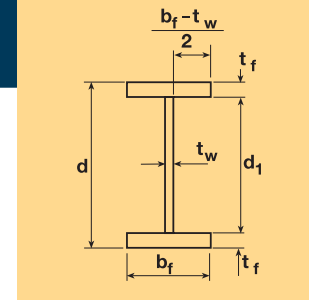

Welded Beams

Table 12 Welded Beams — Properties for Assessing Section Capacity

Designation	Yield Stress		Form Factor k_f	About x-axis		About y-axis		Yield Stress	Form Factor k_f	About x-axis		About y-axis		Designation		
	Flange	Web		Compact-ness	Z_{ex}	Compact-ness	Z_{ey}			Flange	Web	Compact-ness	Z_{ex}		Compact-ness	Z_{ey}
	f_y	f_y								f_y	f_y					
300PLUS*								AS/NZS 3679.2-400								
1200 WB 455	280	300	0.837	C	28200	C	5000	360	380	0.820	N	28100	C	5000	1200 WB 455	
423	280	300	0.825	C	25800	C	4500	360	380	0.806	N	25700	N	4500	423	
392	280	300	0.811	C	23400	N	4000	360	380	0.791	N	23300	N	3900	392	
342	280	300	0.783	C	19800	C	2560	360	380	0.760	N	19600	C	2560	342	
317	280	300	0.766	C	17900	C	2240	360	380	0.741	N	17700	N	2230	317	
278	280	300	0.733	C	15000	C	1530	360	380	0.705	N	14900	N	1530	278	
249	280	300	0.701	C	12900	C	949	360	380	0.670	N	12800	C	949	249	
1000 WB 322	280	300	0.832	C	16400	C	2560	360	380	0.807	C	16400	C	2560	1000 WB 322	
296	280	300	0.817	C	14800	C	2240	360	380	0.791	C	14800	N	2230	296	
258	280	300	0.790	C	12300	C	1530	360	380	0.760	C	12300	N	1530	258	
215	300	300	0.738	C	9570	C	903	380	380	0.704	C	9570	N	887	215	
900 WB 282	280	310	0.845	C	13600	C	2560	360	400	0.830	N	13500	C	2560	900 WB 282	
257	280	310	0.830	C	12200	C	2240	360	400	0.813	N	12000	N	2220	257	
218	280	310	0.800	C	9960	C	1530	360	400	0.780	N	9840	N	1530	218	
175	300	310	0.744	C	7500	C	901	380	400	0.721	N	7320	N	882	175	
800 WB 192	280	310	0.824	C	8060	C	1260	360	400	0.808	N	7850	C	1260	800 WB 192	
168	280	310	0.799	C	6840	C	946	360	400	0.781	N	6640	C	946	168	
146	300	310	0.763	N	5710	C	757	380	400	0.744	N	5510	N	754	146	
122	300	310	0.718	N	4530	N	498	380	400	0.695	N	4340	N	486	122	
700 WB 173	280	310	0.850	C	6390	C	1060	360	400	0.833	C	6390	C	1060	700 WB 173	
150	280	310	0.828	C	5370	C	782	360	400	0.807	C	5370	C	782	150	
130	300	310	0.795	C	4490	C	626	380	400	0.773	C	4490	C	626	130	
115	300	310	0.767	C	3790	N	498	380	400	0.742	C	3790	N	486	115	

* 300PLUS welded sections are produced to exceed the minimum requirements of AS/NZS 3679.2-300.

Notes

1. For 300PLUS sections the tensile strength (f_u) is 430 MPa.
2. For Grade 400 sections the tensile strength (f_u) is 480 MPa.
3. C: Compact Section; N: Non-compact Section; S: Slender Section.

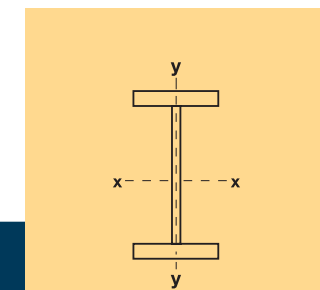
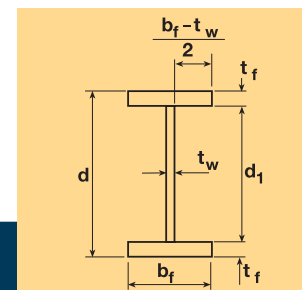

Welded Columns

Table 13 Welded Columns — Dimensions and Properties

Designation	Depth of Section d	Flange		Web Thickness t_w	Depth Between Flanges d_1	d_1	t_w	Gross Area of Cross-Section A_g	About x-axis				About y-axis				Torsion Constant J	Warping Constant I_w	Designation
		Width b_f	Thickness t_f						$(b_f - t_w)$	$2t_f$	I_x	Z_x	S_x	r_x	I_y	Z_y			
kg/m	mm	mm	mm	mm	mm	mm	mm	mm ²	10 ⁶ mm ⁴	10 ³ mm ³	10 ³ mm ³	mm	10 ⁶ mm ⁴	10 ³ mm ³	10 ³ mm ³	mm	10 ³ mm ⁴	10 ⁹ mm ⁶	
500 WC 440	480	500	40	40	400	10.0	5.75	56000	2150	8980	10400	196	835	3340	5160	122	30100	40400	500 WC 440
414	480	500	40	32	400	12.5	5.85	52800	2110	8800	10100	200	834	3340	5100	126	25400	40400	414
383	472	500	36	32	400	12.5	6.50	48800	1890	7990	9130	197	751	3000	4600	124	19900	35700	383
340	514	500	32	25	450	18.0	7.42	43200	2050	7980	8980	218	667	2670	4070	124	13100	38800	340
290	506	500	28	20	450	22.5	8.57	37000	1750	6930	7700	218	584	2330	3540	126	8420	33300	290
267	500	500	25	20	450	22.5	9.60	34000	1560	6250	6950	214	521	2080	3170	124	6370	29400	267
228	490	500	20	20	450	22.5	12.0	29000	1260	5130	5710	208	417	1670	2540	120	3880	23000	228
400 WC 361	430	400	40	40	350	8.75	4.50	46000	1360	6340	7460	172	429	2140	3340	96.5	24800	16300	400 WC 361
328	430	400	40	28	350	12.5	4.65	41800	1320	6140	7100	178	427	2140	3270	101	19200	16200	328
303	422	400	36	28	350	12.5	5.17	38600	1180	5570	6420	175	385	1920	2950	99.8	14800	14300	303
270	414	400	32	25	350	14.0	5.86	34400	1030	4950	5660	173	342	1710	2610	99.8	10400	12500	270
212	400	400	25	20	350	17.5	7.60	27000	776	3880	4360	169	267	1330	2040	99.4	5060	9380	212
181	390	400	20	20	350	17.5	9.50	23000	620	3180	3570	164	214	1070	1640	96.4	3080	7310	181
144	382	400	16	16	350	21.9	12.0	18400	486	2550	2830	163	171	854	1300	96.3	1580	5720	144
350 WC 280	355	350	40	28	275	9.82	4.03	35700	747	4210	4940	145	286	1640	2500	89.6	16500	7100	350 WC 280
258	347	350	36	28	275	9.82	4.47	32900	661	3810	4450	142	258	1470	2260	88.5	12700	6230	258
230	339	350	32	25	275	11.0	5.08	29300	573	3380	3910	140	229	1310	2000	88.4	8960	5400	230
197	331	350	28	20	275	13.8	5.89	25100	486	2940	3350	139	200	1140	1740	89.3	5750	4600	197

Notes

- All welds to AS/NZS 1554.1 Category SP (deep penetration).
- Web to flange joints develop the minimum tensile strength of a 16 mm web only.
- Flame cut surfaces not incorporated in welds have a minimum surface roughness of class 2 as defined in WTIA Technical Note 5.

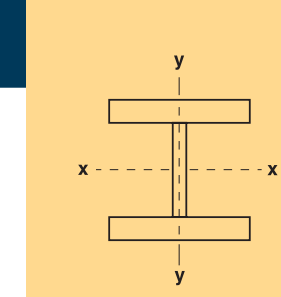
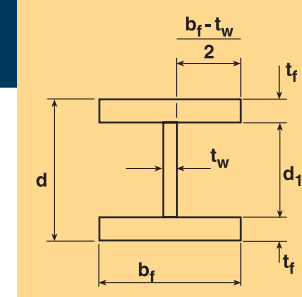

Welded Columns

Table 14 Welded Columns — Properties for Assessing Section Capacity

Designation	Yield Stress		Form Factor k_f	About x-axis		About y-axis		Yield Stress	Form Factor k_f	About x-axis		About y-axis		Designation		
	Flange f_y	Web f_y		Compact-ness	Z_{ex}	Compact-ness	Z_{ey}			Flange f_y	Web f_y	Compact-ness	Z_{ex}		Compact-ness	Z_{ey}
	MPa	MPa								10^3mm^3	10^3mm^3					
300PLUS*								AS/NZS 3679.2-400								
500 WC 440	280	280	1.00	C	10400	C	5010	360	360	1.00	C	10400	C	5010	500 WC 440	
414	280	280	1.00	C	10100	C	5010	360	360	1.00	C	10100	C	5010	414	
383	280	280	1.00	C	9130	C	4510	360	360	1.00	C	9130	C	4510	383	
340	280	280	1.00	C	8980	C	4000	360	360	1.00	N	8830	N	3920	340	
290	280	300	1.00	N	7570	N	3410	360	380	1.00	N	7410	N	3310	290	
267	280	300	1.00	N	6700	N	2970	360	380	1.00	N	6540	N	2860	267	
228	300	300	1.00	N	5210	N	2200	380	380	0.964	S	4860	N	2100	228	
400 WC 361	280	280	1.00	C	7470	C	3210	360	360	1.00	C	7470	C	3210	400 WC 361	
328	280	280	1.00	C	7100	C	3200	360	360	1.00	C	7100	C	3200	328	
303	280	280	1.00	C	6420	C	2880	360	360	1.00	C	6420	C	2880	303	
270	280	280	1.00	C	5660	C	2560	360	360	1.00	C	5660	C	2560	270	
212	280	300	1.00	N	4360	N	2000	360	380	1.00	N	4270	N	1950	212	
181	300	300	1.00	N	3410	N	1510	380	380	1.00	N	3330	N	1460	181	
144	300	300	1.00	N	2590	N	1120	380	380	0.964	S	2410	N	1070	144	
350 WC 280	280	280	1.00	C	4940	C	2450	360	360	1.00	C	4940	C	2450	350 WC 280	
258	280	280	1.00	C	4450	C	2210	360	360	1.00	C	4450	C	2210	258	
230	280	280	1.00	C	3910	C	1960	360	360	1.00	C	3910	C	1960	230	
197	280	300	1.00	C	3350	C	1720	360	380	1.00	C	3350	C	1720	197	

* 300PLUS welded sections are produced to exceed the minimum requirements of AS/NZS 3679.2-300.

Notes

1. For 300PLUS sections the tensile strength (f_u) is 430 MPa.
2. For Grade 400 sections the tensile strength (f_u) is 480 MPa.
3. C: Compact Section; N: Non-compact Section; S: Slender Section.

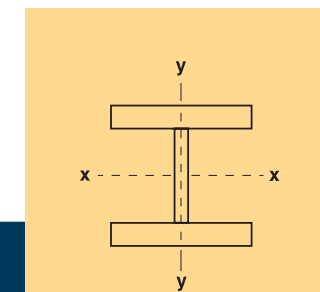
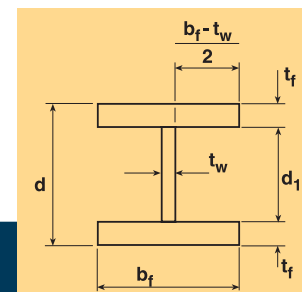

Universal Beams

Table 15 Universal Beams — Dimensions and Properties

Designation	Depth of Section d	Flange		Web Thickness t_w	Root Radius r_1	Depth Between Flanges d_1	d_1	$(b_f - t_w)$	Gross Area of Cross-Section A_g	About x-axis				About y-axis				Torsion Constant J	Warping Constant I_w	Designation
		Width b_f	Thickness t_f							I_x	Z_x	S_x	r_x	I_y	Z_y	S_y	r_y			
kg/m	mm	mm	mm	mm	mm	mm		mm ²	10^6 mm ⁴	10^3 mm ³	10^3 mm ³	mm	10^6 mm ⁴	10^3 mm ³	10^3 mm ³	mm	10^3 mm ⁴	10^9 mm ⁶		
610 UB 125	612	229	19.6	11.9	14.0	572	48.1	5.54	16000	986	3230	3680	249	39.3	343	536	49.6	1560	3450	610 UB 125
113	607	228	17.3	11.2	14.0	572	51.1	6.27	14500	875	2880	3290	246	34.3	300	469	48.7	1140	2980	113
101	602	228	14.8	10.6	14.0	572	54.0	7.34	13000	761	2530	2900	242	29.3	257	402	47.5	790	2530	101
530 UB 92.4	533	209	15.6	10.2	14.0	502	49.2	6.37	11800	554	2080	2370	217	23.8	228	355	44.9	775	1590	530 UB 92.4
82.0	528	209	13.2	9.6	14.0	502	52.3	7.55	10500	477	1810	2070	213	20.1	193	301	43.8	526	1330	82.0
460 UB 82.1	460	191	16.0	9.9	11.4	428	43.3	5.66	10500	372	1610	1840	188	18.6	195	303	42.2	701	919	460 UB 82.1
74.6	457	190	14.5	9.1	11.4	428	47.1	6.24	9520	335	1460	1660	188	16.6	175	271	41.8	530	815	74.6
67.1	454	190	12.7	8.5	11.4	428	50.4	7.15	8580	296	1300	1480	186	14.5	153	238	41.2	378	708	67.1
410 UB 59.7	406	178	12.8	7.8	11.4	381	48.8	6.65	7640	216	1060	1200	168	12.1	135	209	39.7	337	467	410 UB 59.7
53.7	403	178	10.9	7.6	11.4	381	50.1	7.82	6890	188	933	1060	165	10.3	115	179	38.6	234	394	53.7
360 UB 56.7	359	172	13.0	8.0	11.4	333	41.6	6.31	7240	161	899	1010	149	11.0	128	198	39.0	338	330	360 UB 56.7
50.7	356	171	11.5	7.3	11.4	333	45.6	7.12	6470	142	798	897	148	9.60	112	173	38.5	241	284	50.7
44.7	352	171	9.7	6.9	11.4	333	48.2	8.46	5720	121	689	777	146	8.10	94.7	146	37.6	161	237	44.7
310 UB 46.2	307	166	11.8	6.7	11.4	284	42.3	6.75	5930	100	654	729	130	9.01	109	166	39.0	233	197	310 UB 46.2
40.4	304	165	10.2	6.1	11.4	284	46.5	7.79	5210	86.4	569	633	129	7.65	92.7	142	38.3	157	165	40.4
32.0	298	149	8.0	5.5	13.0	282	51.3	8.97	4080	63.2	424	475	124	4.42	59.3	91.8	32.9	86.5	92.9	32.0
250 UB 37.3	256	146	10.9	6.4	8.9	234	36.6	6.40	4750	55.7	435	486	108	5.66	77.5	119	34.5	158	85.2	250 UB 37.3
31.4	252	146	8.6	6.1	8.9	234	38.4	8.13	4010	44.5	354	397	105	4.47	61.2	94.2	33.4	89.3	65.9	31.4
25.7	248	124	8.0	5.0	12.0	232	46.4	7.44	3270	35.4	285	319	104	2.55	41.1	63.6	27.9	67.4	36.7	25.7
200 UB 29.8	207	134	9.6	6.3	8.9	188	29.8	6.65	3820	29.1	281	316	87.3	3.86	57.5	88.4	31.8	105	37.6	200 UB 29.8
25.4	203	133	7.8	5.8	8.9	188	32.3	8.15	3230	23.6	232	260	85.4	3.06	46.1	70.9	30.8	62.7	29.2	25.4
22.3	202	133	7.0	5.0	8.9	188	37.5	9.14	2870	21.0	208	231	85.5	2.75	41.3	63.4	31.0	45.0	26.0	22.3
18.2	198	99	7.0	4.5	11.0	184	40.9	6.75	2320	15.8	160	180	82.6	1.14	23.0	35.7	22.1	38.6	10.4	18.2
180 UB 22.2	179	90	10.0	6.0	8.9	159	26.5	4.20	2820	15.3	171	195	73.6	1.22	27.1	42.3	20.8	81.6	8.71	180 UB 22.2
18.1	175	90	8.0	5.0	8.9	159	31.8	5.31	2300	12.1	139	157	72.6	0.975	21.7	33.7	20.6	44.8	6.80	18.1
16.1	173	90	7.0	4.5	8.9	159	35.3	6.11	2040	10.6	123	138	72.0	0.853	19.0	29.4	20.4	31.5	5.88	16.1
150 UB 18.0	155	75	9.5	6.0	8.0	136	22.7	3.63	2300	9.05	117	135	62.8	0.672	17.9	28.2	17.1	60.5	3.56	150 UB 18.0
14.0	150	75	7.0	5.0	8.0	136	27.2	5.00	1780	6.66	88.8	102	61.1	0.495	13.2	20.8	16.6	28.1	2.53	14.0

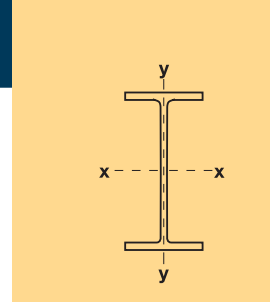
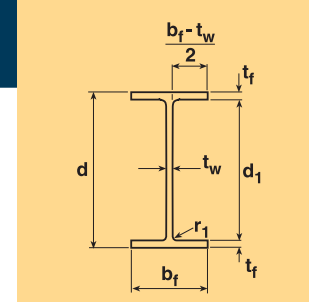

Universal Beams

Table 16 Universal Beams — Properties for Assessing Section Capacity

Designation	Yield Stress		Form Factor k_f	About x-axis		About y-axis		Yield Stress		Form Factor k_f	About x-axis		About y-axis		Designation
	Flange	Web		Compact-ness	Z_{ex} 10^3mm^3	Compact-ness	Z_{ey} 10^3mm^3	Flange	Web		Compact-ness	Z_{ex} 10^3mm^3	Compact-ness	Z_{ey} 10^3mm^3	
	f_y MPa	f_y MPa						f_y MPa	f_y MPa						
300PLUS*								AS/NZS 3679.1-350							
610 UB 125	280	300	0.950	C	3680	C	515	340	340	0.916	C	3680	C	515	610 UB 125
113	280	300	0.926	C	3290	C	451	340	340	0.891	C	3290	C	451	113
101	300	320	0.888	C	2900	C	386	340	360	0.867	C	2900	C	386	101
530 UB 92.4	300	320	0.928	C	2370	C	342	340	360	0.907	C	2370	C	342	530 UB 92.4
82.0	300	320	0.902	C	2070	C	289	340	360	0.880	C	2070	C	289	82.0
460 UB 82.1	300	320	0.979	C	1840	C	292	340	360	0.956	C	1840	C	292	460 UB 82.1
74.6	300	320	0.948	C	1660	C	262	340	360	0.926	C	1660	C	262	74.6
67.1	300	320	0.922	C	1480	C	230	340	360	0.901	C	1480	C	230	67.1
410 UB 59.7	300	320	0.938	C	1200	C	203	340	360	0.918	C	1200	C	203	410 UB 59.7
53.7	320	320	0.913	C	1060	C	173	360	360	0.894	N	1050	N	172	53.7
360 UB 56.7	300	320	0.996	C	1010	C	193	340	360	0.974	C	1010	C	193	360 UB 56.7
50.7	300	320	0.963	C	897	C	168	340	360	0.943	C	897	C	168	50.7
44.7	320	320	0.930	N	770	N	140	360	360	0.911	N	762	N	139	44.7
310 UB 46.2	300	320	0.991	C	729	C	163	340	360	0.972	C	729	C	163	310 UB 46.2
40.4	320	320	0.952	C	633	C	139	360	360	0.936	N	629	N	138	40.4
32.0	320	320	0.915	N	467	N	86.9	360	360	0.898	N	462	N	85.7	32.0
250 UB 37.3	320	320	1.00	C	486	C	116	360	360	1.00	C	486	C	116	250 UB 37.3
31.4	320	320	1.00	N	395	N	91.4	360	360	0.991	N	392	N	90.3	31.4
25.7	320	320	0.949	C	319	C	61.7	360	360	0.932	C	319	C	61.7	25.7
200 UB 29.8	320	320	1.00	C	316	C	86.3	360	360	1.00	C	316	C	86.3	200 UB 29.8
25.4	320	320	1.00	N	259	N	68.8	360	360	1.00	N	257	N	68.0	25.4
22.3	320	320	1.00	N	227	N	60.3	360	360	1.00	N	225	N	59.4	22.3
18.2	320	320	0.990	C	180	C	34.4	360	360	0.970	C	180	C	34.4	18.2
180 UB 22.2	320	320	1.00	C	195	C	40.7	360	360	1.00	C	195	C	40.7	180 UB 22.2
18.1	320	320	1.00	C	157	C	32.5	360	360	1.00	C	157	C	32.5	18.1
16.1	320	320	1.00	C	138	C	28.4	360	360	1.00	C	138	C	28.4	16.1
150 UB 18.0	320	320	1.00	C	135	C	26.9	360	360	1.00	C	135	C	26.9	150 UB 18.0
14.0	320	320	1.00	C	102	C	19.8	360	360	1.00	C	102	C	19.8	14.0

* 300PLUS replaced Grade 250 as the base grade for these sections in 1994.
300PLUS hot rolled sections are produced to exceed the minimum requirements of AS/NZS 3679.1-300.

Notes

1. For 300PLUS sections the tensile strength (f_u) is 440 MPa.
2. For Grade 350 sections the tensile strength (f_u) is 480 MPa.
3. C: Compact Section; N: Non-compact Section; S: Slender Section.

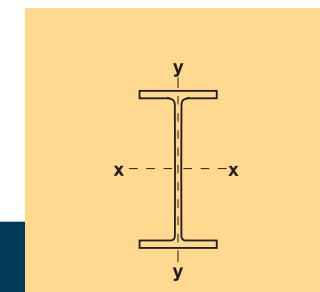
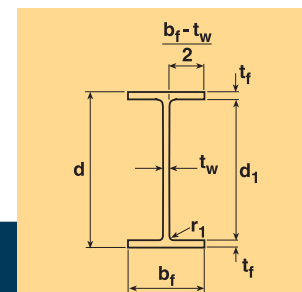

Universal Columns

Table 17 Universal Columns — Dimensions and Properties

Designation	Depth of Section d	Flange		Web Thickness t_w	Root Radius r_1	Depth Between Flanges d_1	d_1 t_w	$(b_f - t_w)$ $2t_f$	Gross Area of Cross-Section A_g	About x-axis				About y-axis				Torsion Constant J	Warping Constant I_w	Designation
		Width b_f	Thickness t_f							I_x 10^6mm^4	Z_x 10^3mm^3	S_x 10^3mm^3	r_x mm	I_y 10^6mm^4	Z_y 10^3mm^3	S_y 10^3mm^3	r_y mm			
310 UC 158	327	311	25.0	15.7	16.5	277	17.7	5.91	20100	388	2370	2680	139	125	807	1230	78.9	3810	2860	310 UC 158
137	321	309	21.7	13.8	16.5	277	20.1	6.80	17500	329	2050	2300	137	107	691	1050	78.2	2520	2390	137
118	315	307	18.7	11.9	16.5	277	23.3	7.89	15000	277	1760	1960	136	90.2	588	893	77.5	1630	1980	118
96.8	308	305	15.4	9.9	16.5	277	28.0	9.58	12400	223	1450	1600	134	72.9	478	725	76.7	928	1560	96.8
250 UC 89.5	260	256	17.3	10.5	14.0	225	21.5	7.10	11400	143	1100	1230	112	48.4	378	575	65.2	1040	713	250 UC 89.5
72.9	254	254	14.2	8.6	14.0	225	26.2	8.64	9320	114	897	992	111	38.8	306	463	64.5	586	557	72.9
200 UC 59.5	210	205	14.2	9.3	11.4	181	19.5	6.89	7620	61.3	584	656	89.7	20.4	199	303	51.7	477	195	200 UC 59.5
52.2	206	204	12.5	8.0	11.4	181	22.7	7.84	6660	52.8	512	570	89.1	17.7	174	264	51.5	325	166	52.2
46.2	203	203	11.0	7.3	11.4	181	24.8	8.90	5900	45.9	451	500	88.2	15.3	151	230	51.0	228	142	46.2
150 UC 37.2	162	154	11.5	8.1	8.9	139	17.1	6.34	4730	22.2	274	310	68.4	7.01	91.0	139	38.5	197	39.6	150 UC 37.2
30.0	158	153	9.4	6.6	8.9	139	21.0	7.79	3860	17.6	223	250	67.5	5.62	73.4	112	38.1	109	30.8	30.0
23.4	152	152	6.8	6.1	8.9	139	22.8	10.7	2980	12.6	166	184	65.1	3.98	52.4	80.2	36.6	50.2	21.1	23.4
100 UC 14.8	97	99	7.0	5.0	10.0	83.0	16.6	6.71	1890	3.18	65.6	74.4	41.1	1.14	22.9	35.2	24.5	34.9	2.30	100 UC 14.8

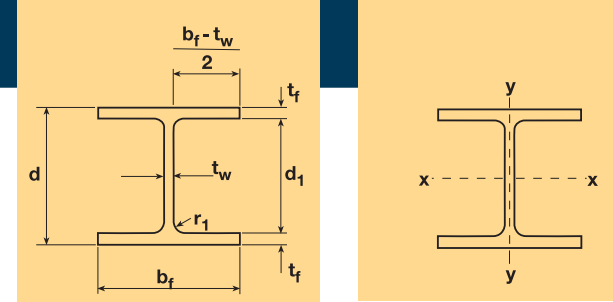

Universal Columns

Table 18 Universal Columns — Properties for Assessing Section Capacity

Designation	Yield Stress		Form Factor k_f	About x-axis		About y-axis		Yield Stress	Form Factor k_f	About x-axis		About y-axis		Designation		
	Flange f_y	Web f_y		Compact-ness	Z_{ex}	Compact-ness	Z_{ey}			Flange f_y	Web f_y	Compact-ness	Z_{ex}		Compact-ness	Z_{ey}
	MPa	MPa			10^3mm^3		10^3mm^3			MPa	MPa		10^3mm^3			10^3mm^3
300PLUS*								AS/NZS 3679.1-350								
310 UC 158	280	300	1.00	C	2680	C	1210	340	340	1.00	C	2680	C	1210	310 UC 158	
137	280	300	1.00	C	2300	C	1040	340	340	1.00	C	2300	C	1040	137	
118	280	300	1.00	C	1960	C	882	340	340	1.00	N	1950	N	878	118	
96.8	300	320	1.00	N	1560	N	694	340	360	1.00	N	1550	N	684	96.8	
250 UC 89.5	280	320	1.00	C	1230	C	567	340	360	1.00	C	1230	C	567	250 UC 89.5	
72.9	300	320	1.00	N	986	N	454	340	360	1.00	N	977	N	448	72.9	
200 UC 59.5	300	320	1.00	C	656	C	299	340	360	1.00	C	656	C	299	200 UC 59.5	
52.2	300	320	1.00	C	570	C	260	340	360	1.00	N	569	N	260	52.2	
46.2	300	320	1.00	N	494	N	223	340	360	1.00	N	490	N	219	46.2	
150 UC 37.2	300	320	1.00	C	310	C	137	340	360	1.00	C	310	C	137	150 UC 37.2	
30.0	320	320	1.00	C	250	C	110	360	360	1.00	N	248	N	109	30.0	
23.4	320	320	1.00	N	176	N	73.5	360	360	1.00	N	174	N	72.3	23.4	
100 UC 14.8	320	320	1.00	C	74.4	C	34.4	360	360	1.00	C	74.4	C	34.4	100 UC 14.8	

* 300PLUS replaced Grade 250 as the base grade for these sections in 1994.

300PLUS hot rolled sections are produced to exceed the minimum requirements of AS/NZS 3679.1-300.

Notes

1. For 300PLUS sections the tensile strength (f_u) is 440 MPa.
2. For Grade 350 sections the tensile strength (f_u) is 480 MPa.
3. C: Compact Section; N: Non-compact Section; S: Slender Section.

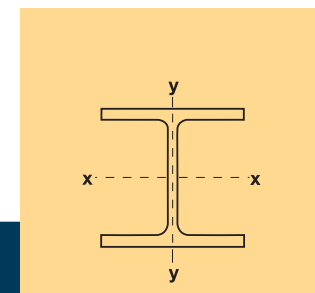
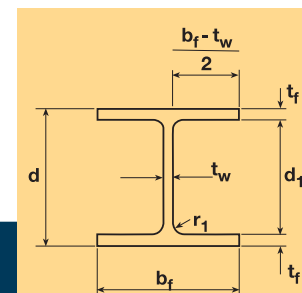

Tapered Flange Beams

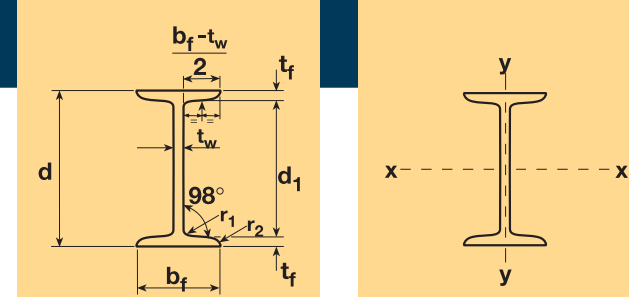

Table 19 Tapered Flange Beams — Dimensions and Properties

Designation	Mass per metre	Depth of Section d	Flange		Web Thickness t_w	Radii		Depth Between Flanges d_1	$(b_f - t_w)$			Gross Area of Cross Section A_g	About x-axis				About y-axis				Torsion Constant J	Warping Constant I_w	Designation
			Width b_f	Thickness t_f		Root r_1	Toe r_2		d_1	t_w	$2t_f$		I_x	Z_x	S_x	r_x	I_y	Z_y	S_y	r_y			
	kg/m	mm	mm	mm	mm	mm	mm	mm	mm	mm	mm	mm ²	10 ⁶ mm ⁴	10 ³ mm ³	10 ³ mm ³	mm	10 ⁶ mm ⁴	10 ³ mm ³	10 ³ mm ³	mm	10 ³ mm ⁴	10 ⁹ mm ⁶	
125 TFB	13.1	125	65.0	8.5	5.0	8.0	4.0	108	21.6	3.53	1670	4.34	69.4	80.3	50.9	0.337	10.4	17.2	14.2	40.2	1.14	125 TFB	
100 TFB	7.20	100	45.0	6.0	4.0	7.0	3.0	88	22.0	3.42	917	1.46	29.2	34.1	39.9	0.0795	3.53	6.00	9.31	11.6	0.176	100 TFB	

Table 20 Tapered Flange Beams — Properties for Assessing Section Capacity

Designation	Yield Stress		Form Factor k_f	About x-axis		About y-axis		Yield Stress	Form Factor k_f	About x-axis		About y-axis		Designation	
	Flange f_y	Web f_y		Compactness	Z_{ex}	Compactness	Z_{ey}			Flange f_y	Web f_y	Compactness	Z_{ex}		Compactness
	MPa	MPa		10 ³ mm ³		10 ³ mm ³	MPa	MPa		10 ³ mm ³		10 ³ mm ³			
	300PLUS*							AS/NZS 3679.1-350							
125 TFB	320	320	1.00	C	80.3	C	15.6	360	360	1.00	C	80.3	C	15.6	125 TFB
100 TFB	320	320	1.00	C	34.1	C	5.30	360	360	1.00	C	34.1	C	5.30	100 TFB

*300PLUS replaced Grade 250 as the base grade for these sections in 1997.

300PLUS hot rolled sections are produced to exceed the minimum requirements of AS/NZS 3679.1-300

Notes

- For 300PLUS sections the tensile strength (f_u) is 440 MPa.
- For Grade 350 sections the tensile strength (f_u) is 480 MPa.
- C: Compact Section; N: Non-compact Section; S: Slender Section.

Parallel Flange Channels

Table 21 Parallel Flange Channels — Dimensions and Properties

Designation	Mass per metre	Depth of Section d	Flange		Web Thickness t_w	Root Radius r_1	Depth Between Flanges d_1	$(b_f - t_w)$		Gross Area of Cross-Section A_g	Coordinate of Centroid x_L	Coordinate of Shear Centre x_0	About x-axis				About y-axis				Torsion Constant J	Warping Constant I_w	Designation	
			Width b_f	Thickness t_f				d_1	t_f				I_x	Z_x	S_x	r_x	I_y	Z_{yR}	Z_{yL}	S_y				r_y
	kg/m	mm	mm	mm	mm	mm	mm	mm	mm	mm ²	mm	mm	10 ⁶ mm ⁴	10 ³ mm ³	10 ³ mm ³	mm	10 ⁶ mm ⁴	10 ³ mm ³	10 ³ mm ³	10 ³ mm ³	mm	10 ³ mm ⁴	10 ⁹ mm ⁶	
380 PFC	55.2	380	100	17.5	10.0	14.0	345	34.5	5.14	7030	27.5	56.7	152	798	946	147	6.48	89.4	236	161	30.4	472	151	380 PFC
300 PFC	40.1	300	90	16.0	8.0	14.0	268	33.5	5.13	5110	27.2	56.1	72.4	483	564	119	4.04	64.4	148	117	28.1	290	58.2	300 PFC
250 PFC	35.5	250	90	15.0	8.0	12.0	220	27.5	5.47	4520	28.6	58.5	45.1	361	421	99.9	3.64	59.3	127	107	28.4	238	35.9	250 PFC
230 PFC	25.1	230	75	12.0	6.5	12.0	206	31.7	5.71	3200	22.6	46.7	26.8	233	271	91.4	1.76	33.6	77.8	61.0	23.5	108	15.0	230 PFC
200 PFC	22.9	200	75	12.0	6.0	12.0	176	29.3	5.75	2920	24.4	50.5	19.1	191	221	80.9	1.65	32.7	67.8	58.9	23.8	101	10.6	200 PFC
180 PFC	20.9	180	75	11.0	6.0	12.0	158	26.3	6.27	2660	24.5	50.3	14.1	157	182	72.9	1.51	29.9	61.5	53.8	23.8	81.4	7.82	180 PFC
150 PFC	17.7	150	75	9.5	6.0	10.0	131	21.8	7.26	2250	24.9	51.0	8.34	111	129	60.8	1.29	25.7	51.6	46.0	23.9	54.9	4.59	150 PFC
125 PFC	11.9	125	65	7.5	4.7	8.0	110	23.4	8.04	1520	21.8	45.0	3.97	63.5	73.0	51.1	0.658	15.2	30.2	27.2	20.8	23.1	1.64	125 PFC
100 PFC	8.33	100	50	6.7	4.2	8.0	86.6	20.6	6.84	1060	16.7	33.9	1.74	34.7	40.3	40.4	0.267	8.01	16.0	14.4	15.9	13.2	0.424	100 PFC
75 PFC	5.92	75	40	6.1	3.8	8.0	62.8	16.5	5.94	754	13.7	27.2	0.683	18.2	21.4	30.1	0.120	4.56	8.71	8.20	12.6	8.13	0.106	75 PFC

Table 22 Parallel Flange Channels — Properties for Assessing Section Capacity

Designation	Yield Stress		Form Factor k_f	About x-axis		About y-axis		Yield Stress		Form Factor k_f	About x-axis		About y-axis		Designation
	Flange f_y	Web f_y		Z_{ex}	Load A Z_{ey}	Load B Z_{ey}	Flange f_y	Web f_y	Z_{ex}		Load A Z_{ey}	Load B Z_{ey}			
	MPa	MPa					10 ³ mm ³	10 ³ mm ³					10 ³ mm ³	MPa	
	300PLUS*							AS/NZS 3679.1-350							
380 PFC	280	320	1.00	946	115	134	340	360	1.00	946	104	134	380 PFC		
300 PFC	300	320	1.00	564	82.3	96.6	340	360	1.00	564	77.2	96.6	300 PFC		
250 PFC	300	320	1.00	421	88.7	89.0	340	360	1.00	421	84.9	89.0	250 PFC		
230 PFC	300	320	1.00	271	45.1	50.4	340	360	1.00	271	42.6	50.4	230 PFC		
200 PFC	300	320	1.00	221	46.7	49.1	340	360	1.00	221	44.5	49.1	200 PFC		
180 PFC	300	320	1.00	182	44.9	44.8	340	360	1.00	182	44.1	44.8	180 PFC		
150 PFC	320	320	1.00	129	38.5	38.5	360	360	1.00	129	38.5	38.5	150 PFC		
125 PFC	320	320	1.00	72.8	22.8	22.8	360	360	1.00	72.0	22.5	22.8	125 PFC		
100 PFC	320	320	1.00	40.3	12.0	12.0	360	360	1.00	40.3	12.0	12.0	100 PFC		
75 PFC	320	320	1.00	21.4	6.84	6.84	360	360	1.00	21.4	6.84	6.84	75 PFC		

* 300PLUS replaced Grade 250 as the base grade for these sections in 1994.
300PLUS hot rolled sections are produced to exceed the minimum requirements of AS/NZS 3679.1-300.

- Notes**
- For 300PLUS sections the tensile strength (f_u) is 440 MPa.
 - For Grade 350 sections the tensile strength (f_u) is 480 MPa.

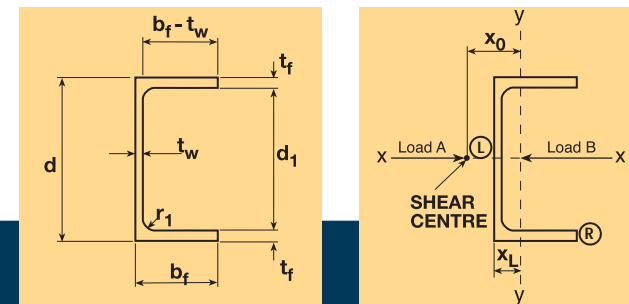

Universal Bearing Piles (refer Note 4)

Table 23 Universal Bearing Piles — Dimensions and Properties

Designation	Depth of Section d	Flange		Web Thickness t_w	Root Radius r_1	Depth Between Flanges d_1	d_1	$(b_f - t_w)$	Gross Area of Cross-Section A_g	About x-axis				About y-axis				Torsion Constant J	Warping Constant I_w	Designation
		Width b_f	Thickness t_f							I_x	Z_x	S_x	r_x	I_y	Z_y	S_y	r_y			
kg/m	mm	mm	mm	mm	mm	mm			mm ²	10 ⁶ mm ⁴	10 ³ mm ³	10 ³ mm ³	mm	10 ⁶ mm ⁴	10 ³ mm ³	10 ³ mm ³	mm	10 ³ mm ⁴	10 ⁹ mm ⁶	
310 UBP 149	318	316	20.6	20.5	16.5	277	13.5	7.14	19000	330	2080	2370	132	109	691	1070	75.8	2970	2410	310 UBP 149
110	308	311	15.4	15.3	16.5	277	18.1	9.57	14000	236	1530	1720	130	76.6	494	759	73.9	1240	1640	110
78.8	299	306	11.1	11.1	16.5	277	24.9	13.3	10100	165	1100	1220	128	53.1	347	530	72.5	484	1100	78.8
200 UBP 122	230	220	25.0	25.0	11.4	180	7.20	3.90	15600	129	1120	1340	91.0	44.6	406	635	53.5	3540	469	200 UBP 122

Table 24 Universal Bearing Piles — Properties for Assessing Section Capacity

Designation	Yield Stress		Form Factor k_f	About x-axis		About y-axis		Yield Stress		Form Factor k_f	About x-axis		About y-axis		Designation
	Flange f_y	Web f_y		Compact-ness	Z_{ex}	Compact-ness	Z_{ey}	Flange f_y	Web f_y		Compact-ness	Z_{ex}	Compact-ness	Z_{ey}	
	MPa	MPa			10 ³ mm ³		10 ³ mm ³	MPa	MPa			10 ³ mm ³		10 ³ mm ³	
	300PLUS*							AS/NZS 3679.1-350							
310 UBP 149	280	280	1.00	C	2370	C	1040	340	340	1.00	C	2370	C	1040	310 UBP 149
110	300	300	1.00	N	1680	N	718	340	340	1.00	N	1660	N	708	110
78.8	300	300	1.00	N	1130	N	460	340	340	1.00	N	1110	N	450	78.8
200 UBP 122	280	280	1.00	C	1340	C	609	340	340	1.00	C	1340	C	609	200 UBP 122

*300PLUS hot rolled sections are produced to exceed the minimum requirements of AS/NZS 3679.1-300.

Notes

- For 300PLUS sections the tensile strength (f_u) is 440 MPa.
- For Grade 350 sections the tensile strength (f_u) is 480 MPa.
- C: Compact Section; N: Non-compact Section; S: Slender Section.
- These sections are generally not stocked and are available for project orders only subject to enquiry from your nearest OneSteel Sales Office.

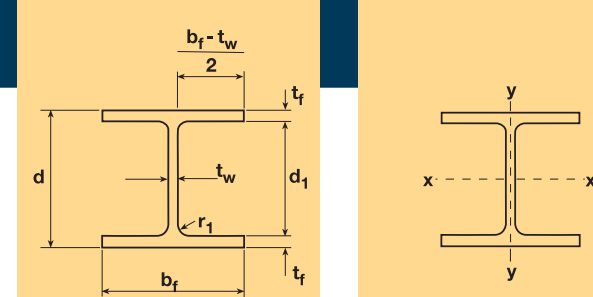

Equal Angles

Table 25 Equal Angles — x-axis and y-axis — Dimensions and Properties

Designation		Mass per metre	Actual Thickness	Radii		Gross Area of Cross-Section	Coordinate of Centroid		About x-axis				About y-axis					Torsion Constant	Designation			
Leg-size	Nominal Thickness			Root	Toe		(b_1-t)	r_L	r_R	y_1	Z_{x1}	S_x	r_x	I_y	x_3	Z_{y3}	x_5			Z_{y5}	S_y	r_y
$b_1 \times b_1$	t	r_1	r_2	t	A_g	p_B	p_T	I_x	y_4	Z_{x4}	r_x	I_y	x_3	Z_{y3}	x_5	Z_{y5}	S_y	r_y	J			
mm mm	mm	mm	mm	mm	mm ²	mm	mm	10 ⁶ mm ⁴	mm	10 ³ mm ³	mm	10 ⁶ mm ⁴	mm	10 ³ mm ³	mm	10 ³ mm ³	10 ³ mm ³	mm	10 ³ mm ⁴			
200 x 200 x 26 EA	76.8	26.0	18.0	5.0	6.69	9780	59.3	141	56.8	141	402	643	76.2	14.9	73.9	202	83.8	178	329	39.0	2250	200 x 200 x 26 EA
20 EA	60.1	20.0	18.0	5.0	9.00	7660	57.0	143	45.7	141	323	511	77.2	11.8	72.9	162	80.6	147	260	39.3	1060	20 EA
18 EA	54.4	18.0	18.0	5.0	10.1	6930	56.2	144	41.7	141	295	464	77.6	10.8	72.6	149	79.5	136	236	39.4	778	18 EA
16 EA	48.7	16.0	18.0	5.0	11.5	6200	55.4	145	37.6	141	266	417	77.9	9.72	72.3	135	78.4	124	212	39.6	554	16 EA
13 EA	40.0	13.0	18.0	5.0	14.4	5090	54.2	146	31.2	141	221	344	78.3	8.08	71.9	112	76.6	105	176	39.8	304	13 EA
150 x 150 x 19 EA	42.1	19.0	13.0	5.0	6.89	5360	44.2	106	17.6	106	166	265	57.2	4.60	54.9	83.8	62.6	73.5	135	29.3	657	150 x 150 x 19 EA
16 EA	35.4	15.8	13.0	5.0	8.49	4520	43.0	107	15.1	106	142	225	57.8	3.91	54.3	71.9	60.8	64.2	115	29.4	386	16 EA
12 EA	27.3	12.0	13.0	5.0	11.5	3480	41.5	108	11.9	106	112	175	58.4	3.06	53.7	56.9	58.7	52.1	89.3	29.6	174	12 EA
10 EA	21.9	9.5	13.0	5.0	14.8	2790	40.5	109	9.61	106	90.6	141	58.7	2.48	53.4	46.4	57.3	43.3	72.0	29.8	88.9	10 EA
125 x 125 x 16 EA	29.1	15.8	10.0	5.0	6.91	3710	36.8	88.2	8.43	88.4	95.4	153	47.7	2.20	45.4	48.5	52.1	42.3	77.8	24.4	313	125 x 125 x 16 EA
12 EA	22.5	12.0	10.0	5.0	9.42	2870	35.4	89.6	6.69	88.4	75.7	120	48.3	1.73	44.7	38.6	50.1	34.5	60.8	24.5	141	12 EA
10 EA	18.0	9.5	10.0	5.0	12.2	2300	34.4	90.6	5.44	88.4	61.6	96.5	48.7	1.40	44.4	31.5	48.7	28.8	49.0	24.7	71.9	10 EA
8 EA	14.9	7.8	10.0	5.0	15.0	1900	33.7	91.3	4.55	88.4	51.5	80.2	48.9	1.17	44.2	26.5	47.7	24.5	40.8	24.8	40.6	8 EA
100 x 100 x 12 EA	17.7	12.0	8.0	5.0	7.33	2260	29.2	70.8	3.29	70.7	46.6	74.5	38.2	0.857	35.8	23.9	41.3	20.8	37.9	19.5	110	100 x 100 x 12 EA
10 EA	14.2	9.5	8.0	5.0	9.53	1810	28.2	71.8	2.70	70.7	38.2	60.4	38.6	0.695	35.4	19.6	39.9	17.4	30.7	19.6	56.2	10 EA
8 EA	11.8	7.8	8.0	5.0	11.8	1500	27.5	72.5	2.27	70.7	32.0	50.3	38.8	0.582	35.2	16.5	38.9	14.9	25.6	19.7	31.7	8 EA
6 EA	9.16	6.0	8.0	5.0	15.7	1170	26.8	73.2	1.78	70.7	25.2	39.3	39.1	0.458	35.0	13.1	37.9	12.1	20.0	19.8	14.8	6 EA
90 x 90 x 10 EA	12.7	9.5	8.0	5.0	8.47	1620	25.7	64.3	1.93	63.6	30.4	48.3	34.5	0.500	31.9	15.7	36.4	13.8	24.6	17.6	50.5	90 x 90 x 10 EA
8 EA	10.6	7.8	8.0	5.0	10.5	1350	25.0	65.0	1.63	63.6	25.6	40.4	34.8	0.419	31.7	13.2	35.4	11.8	20.5	17.6	28.6	8 EA
6 EA	8.22	6.0	8.0	5.0	14.0	1050	24.3	65.7	1.28	63.6	20.1	31.6	35.0	0.330	31.5	10.5	34.3	9.62	16.1	17.8	13.4	6 EA
75 x 75 x 10 EA	10.5	9.5	8.0	5.0	6.89	1340	22.0	53.0	1.08	53.0	20.4	32.8	28.4	0.282	26.6	10.6	31.1	9.09	16.8	14.5	41.9	75 x 75 x 10 EA
8 EA	8.73	7.8	8.0	5.0	8.62	1110	21.3	53.7	0.913	53.0	17.2	27.5	28.7	0.237	26.4	8.99	30.1	7.87	14.0	14.6	23.8	8 EA
6 EA	6.81	6.0	8.0	5.0	11.5	867	20.5	54.5	0.722	53.0	13.6	21.6	28.9	0.187	26.2	7.15	29.0	6.44	11.0	14.7	11.2	6 EA
5 EA	5.27	4.6	8.0	5.0	15.3	672	19.9	55.1	0.563	53.0	10.6	16.7	29.0	0.147	26.1	5.62	28.1	5.22	8.61	14.8	5.28	5 EA
65 x 65 x 10 EA	9.02	9.5	6.0	3.0	5.84	1150	19.6	45.4	0.691	46.0	15.0	24.3	24.5	0.183	23.7	7.71	27.7	6.60	12.5	12.6	35.1	65 x 65 x 10 EA
8 EA	7.51	7.8	6.0	3.0	7.33	957	19.0	46.0	0.589	46.0	12.8	20.5	24.8	0.154	23.4	6.56	26.8	5.73	10.5	12.7	20.0	8 EA
6 EA	5.87	6.0	6.0	3.0	9.83	748	18.3	46.7	0.471	46.0	10.2	16.2	25.1	0.122	23.1	5.26	25.8	4.71	8.25	12.8	9.37	6 EA
5 EA	4.56	4.6	6.0	3.0	13.1	581	17.7	47.3	0.371	46.0	8.08	12.7	25.3	0.0959	23.0	4.18	25.0	3.83	6.46	12.9	4.36	5 EA
55 x 55 x 6 EA	4.93	6.0	6.0	3.0	8.17	628	15.8	39.2	0.278	38.9	7.14	11.4	21.0	0.0723	19.6	3.69	22.3	3.24	5.82	10.7	7.93	55 x 55 x 6 EA
5 EA	3.84	4.6	6.0	3.0	11.0	489	15.2	39.8	0.220	38.9	5.66	8.93	21.2	0.0571	19.4	2.94	21.5	2.66	4.57	10.8	3.71	5 EA
50 x 50 x 8 EA	5.68	7.8	6.0	3.0	5.41	723	15.2	34.8	0.253	35.4	7.16	11.7	18.7	0.0675	18.1	3.73	21.5	3.14	6.00	9.66	15.2	50 x 50 x 8 EA
6 EA	4.46	6.0	6.0	3.0	7.33	568	14.5	35.5	0.205	35.4	5.79	9.30	19.0	0.0536	17.8	3.01	20.5	2.61	4.76	9.71	7.21	6 EA
5 EA	3.48	4.6	6.0	3.0	9.87	443	13.9	36.1	0.163	35.4	4.61	7.32	19.2	0.0424	17.6	2.40	19.7	2.15	3.75	9.78	3.38	5 EA
3 EA	2.31	3.0	6.0	3.0	15.7	295	13.2	36.8	0.110	35.4	3.11	4.90	19.3	0.0289	17.6	1.65	18.7	1.55	2.53	9.90	1.01	3 EA
45 x 45 x 6 EA	3.97	6.0	5.0	3.0	6.50	506	13.3	31.7	0.146	31.8	4.59	7.41	17.0	0.0383	16.0	2.39	18.8	2.04	3.79	8.71	6.32	45 x 45 x 6 EA
5 EA	3.10	4.6	5.0	3.0	8.78	394	12.7	32.3	0.117	31.8	3.66	5.84	17.2	0.0303	15.8	1.91	18.0	1.68	2.99	8.76	2.96	5 EA
3 EA	2.06	3.0	5.0	3.0	14.0	263	12.0	33.0	0.0790	31.8	2.48	3.92	17.3	0.0206	15.7	1.31	17.0	1.21	2.02	8.85	0.875	3 EA
40 x 40 x 6 EA	3.50	6.0	5.0	3.0	5.67	446	12.0	28.0	0.0997	28.3	3.53	5.75	15.0	0.0265	14.3	1.86	17.0	1.55	2.95	7.71	5.60	40 x 40 x 6 EA
5 EA	2.73	4.6	5.0	3.0	7.70	348	11.5	28.5	0.0801	28.3	2.83	4.55	15.2	0.0209	14.0	1.49	16.2	1.29	2.33	7.75	2.63	5 EA
3 EA	1.83	3.0	5.0	3.0	12.3	233	10.8	29.2	0.0545	28.3	1.93	3.06	15.3	0.0142	13.9	1.02	15.3	0.930	1.58	7.82	0.785	3 EA
30 x 30 x 6 EA	2.56	6.0	5.0	3.0	4.00	326	9.53	20.5	0.0387	21.2	1.83	3.06	10.9	0.0107	10.7	0.993	13.5	0.790	1.59	5.72	4.16	30 x 30 x 6 EA
5 EA	2.01	4.6	5.0	3.0	5.52	256	8.99	21.0	0.0316	21.2	1.49	2.45	11.1	0.00839	10.5	0.799	12.7	0.660	1.26	5.72	1.98	5 EA
3 EA	1.35	3.0	5.0	3.0	9.00	173	8.30	21.7	0.0218	21.2	1.03	1.67	11.2	0.00573	10.3	0.554	11.7	0.488	0.862	5.76	0.605	3 EA
25 x 25 x 6 EA	2.08	6.0	5.0	3.0	3.17	266	8.28	16.7	0.0210	17.7	1.19	2.03	8.89	0.00600	8.97	0.669	11.7	0.513	1.07	4.75	3.44	25 x 25 x 6 EA
5 EA	1.65	4.6	5.0	3.0	4.43	210	7.75	17.3	0.0173	17.7	0.980	1.65	9.07	0.00469	8.73	0.537	11.0	0.428	0.849	4.72	1.66	5 EA
3 EA	1.12	3.0	5.0	3.0	7.33	143	7.07	17.9	0.0121	17.7	0.685	1.13	9.22	0.00319	8.56	0.373	9.99	0.319	0.583	4.73	0.515	3 EA

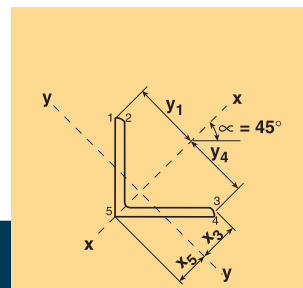
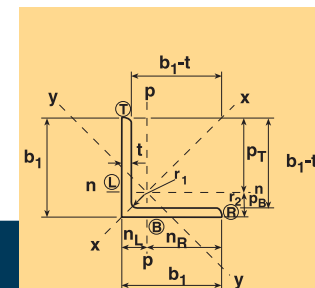

Equal Angles

Table 26 Equal Angles — x-axis and y-axis — Properties for Assessing Section Capacity

Designation	Yield Stress	Form Factor	About x-axis			About y-axis			Yield Stress	Form Factor	About x-axis			About y-axis			Designation
			Load A or C	Load B	Load D	Load A or C	Load B	Load D			Load A or C	Load B	Load D				
														Z_{ex}	Z_{ey}	Z_{ey}	
mm mm mm	f_y	k_f	10^3mm^3	10^3mm^3	10^3mm^3	MPa	k_f	10^3mm^3	10^3mm^3	10^3mm^3	MPa	k_f	10^3mm^3	10^3mm^3	10^3mm^3		
			300PLUS*			AS/NZS 3679.1-350											
200 x 200 x 26 EA	280	1.00	602	267	267	340	1.00	602	267	267	340	1.00	602	267	267	200 x 200 x 26 EA	
20 EA	280	1.00	479	218	220	340	1.00	469	214	220	340	1.00	469	214	220	20 EA	
18 EA	280	1.00	427	196	204	340	1.00	417	192	204	340	1.00	417	192	204	18 EA	
16 EA	300	1.00	369	172	186	340	1.00	362	169	186	340	1.00	362	169	186	16 EA	
13 EA	300	1.00	285	136	158	340	0.956	278	132	158	340	0.956	278	132	158	13 EA	
150 x 150 x 19 EA	280	1.00	248	110	110	340	1.00	248	110	110	340	1.00	248	110	110	150 x 150 x 19 EA	
16 EA	300	1.00	212	95.7	96.3	340	1.00	209	94.5	96.3	340	1.00	209	94.5	96.3	16 EA	
12 EA	300	1.00	155	72.3	78.1	340	1.00	152	70.9	78.1	340	1.00	152	70.9	78.1	12 EA	
10 EA	320	0.958	114	54.5	64.9	360	0.906	111	53.1	64.9	360	0.906	111	53.1	64.9	10 EA	
125 x 125 x 16 EA	300	1.00	143	63.4	63.4	340	1.00	143	63.4	63.4	340	1.00	143	63.4	63.4	125 x 125 x 16 EA	
12 EA	300	1.00	110	50.3	51.7	340	1.00	109	49.6	51.7	340	1.00	109	49.6	51.7	12 EA	
10 EA	320	1.00	83.2	38.9	43.1	360	1.00	81.6	38.1	43.1	360	1.00	81.6	38.1	43.1	10 EA	
8 EA	320	0.943	64.3	30.7	36.8	360	0.892	62.7	29.9	36.8	360	0.892	62.7	29.9	36.8	8 EA	
100 x 100 x 12 EA	300	1.00	69.9	31.1	31.1	340	1.00	69.9	31.1	31.1	340	1.00	69.9	31.1	31.1	100 x 100 x 12 EA	
10 EA	320	1.00	55.1	25.2	26.1	360	1.00	54.4	24.8	26.1	360	1.00	54.4	24.8	26.1	10 EA	
8 EA	320	1.00	43.7	20.4	22.4	360	1.00	42.9	20.0	22.4	360	1.00	42.9	20.0	22.4	8 EA	
6 EA	320	0.906	30.9	14.8	18.1	360	0.856	30.0	14.4	18.1	360	0.856	30.0	14.4	18.1	6 EA	
90 x 90 x 10 EA	320	1.00	45.0	20.4	20.6	360	1.00	44.5	20.1	20.6	360	1.00	44.5	20.1	20.6	90 x 90 x 10 EA	
8 EA	320	1.00	36.0	16.7	17.8	360	1.00	35.4	16.4	17.8	360	1.00	35.4	16.4	17.8	8 EA	
6 EA	320	1.00	25.9	12.4	14.4	360	0.954	25.3	12.1	14.4	360	0.954	25.3	12.1	14.4	6 EA	
75 x 75 x 10 EA	320	1.00	30.5	13.6	13.6	360	1.00	30.5	13.6	13.6	360	1.00	30.5	13.6	13.6	75 x 75 x 10 EA	
8 EA	320	1.00	25.4	11.6	11.8	360	1.00	25.1	11.5	11.8	360	1.00	25.1	11.5	11.8	8 EA	
6 EA	320	1.00	18.7	8.85	9.66	360	1.00	18.4	8.70	9.66	360	1.00	18.4	8.70	9.66	6 EA	
5 EA	320	0.927	13.2	6.47	7.82	360	0.876	12.8	6.30	7.82	360	0.876	12.8	6.30	7.82	5 EA	
65 x 65 x 10 EA	320	1.00	22.5	9.90	9.90	360	1.00	22.5	9.90	9.90	360	1.00	22.5	9.90	9.90	65 x 65 x 10 EA	
8 EA	320	1.00	19.2	8.59	8.59	360	1.00	19.2	8.59	8.59	360	1.00	19.2	8.59	8.59	8 EA	
6 EA	320	1.00	14.7	6.76	7.07	360	1.00	14.5	6.66	7.07	360	1.00	14.5	6.66	7.07	6 EA	
5 EA	320	1.00	10.6	5.05	5.75	360	1.00	10.4	4.94	5.75	360	1.00	10.4	4.94	5.75	5 EA	
55 x 55 x 6 EA	320	1.00	10.7	4.84	4.86	360	1.00	10.5	4.78	4.86	360	1.00	10.5	4.78	4.86	55 x 55 x 6 EA	
5 EA	320	1.00	7.88	3.70	3.98	360	1.00	7.75	3.64	3.98	360	1.00	7.75	3.64	3.98	5 EA	
50 x 50 x 8 EA	320	1.00	10.7	4.71	4.71	360	1.00	10.7	4.71	4.71	360	1.00	10.7	4.71	4.71	50 x 50 x 8 EA	
6 EA	320	1.00	8.69	3.92	3.92	360	1.00	8.69	3.92	3.92	360	1.00	8.69	3.92	3.92	6 EA	
5 EA	320	1.00	6.60	3.08	3.22	360	1.00	6.50	3.03	3.22	360	1.00	6.50	3.03	3.22	5 EA	
3 EA	320	0.907	3.82	1.90	2.32	360	0.858	3.71	1.85	2.32	360	0.858	3.71	1.85	2.32	3 EA	
45 x 45 x 6 EA	320	1.00	6.88	3.06	3.06	360	1.00	6.88	3.06	3.06	360	1.00	6.88	3.06	3.06	45 x 45 x 6 EA	
5 EA	320	1.00	5.39	2.47	2.52	360	1.00	5.32	2.44	2.52	360	1.00	5.32	2.44	2.52	5 EA	
3 EA	320	1.00	3.19	1.55	1.81	360	0.954	3.12	1.52	1.81	360	0.954	3.12	1.52	1.81	3 EA	
40 x 40 x 6 EA	320	1.00	5.29	2.33	2.33	360	1.00	5.29	2.33	2.33	360	1.00	5.29	2.33	2.33	40 x 40 x 6 EA	
5 EA	320	1.00	4.25	1.93	1.93	360	1.00	4.22	1.92	1.93	360	1.00	4.22	1.92	1.93	5 EA	
3 EA	320	1.00	2.59	1.25	1.40	360	1.00	2.54	1.23	1.40	360	1.00	2.54	1.23	1.40	3 EA	
30 x 30 x 6 EA	320	1.00	2.74	1.19	1.19	360	1.00	2.74	1.19	1.19	360	1.00	2.74	1.19	1.19	30 x 30 x 6 EA	
5 EA	320	1.00	2.23	0.990	0.990	360	1.00	2.23	0.990	0.990	360	1.00	2.23	0.990	0.990	5 EA	
3 EA	320	1.00	1.50	0.714	0.732	360	1.00	1.48	0.705	0.732	360	1.00	1.48	0.705	0.732	3 EA	
25 x 25 x 6 EA	320	1.00	1.78	0.769	0.769	360	1.00	1.78	0.769	0.769	360	1.00	1.78	0.769	0.769	25 x 25 x 6 EA	
5 EA	320	1.00	1.47	0.642	0.642	360	1.00	1.47	0.642	0.642	360	1.00	1.47	0.642	0.642	5 EA	
3 EA	320	1.00	1.03	0.479	0.479	360	1.00	1.03	0.479	0.479	360	1.00	1.03	0.479	0.479	3 EA	

* 300PLUS replaced Grade 250 as the base grade for 125x125x8 equal angles and larger in 1994.
 300PLUS replaced Grade 250 as the base grade for 100x100x12 equal angles and smaller in 1997.
 300PLUS not rolled sections are produced to exceed the minimum requirements of AS/NZS 3679.1-300.

Notes 1. For 300PLUS sections the tensile strength (f_{ty}) is 440 MPa.
 2. For Grade 350 sections the tensile strength (f_{ty}) is 480 MPa.

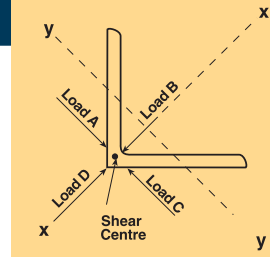

Equal Angles

Table 27 Equal Angles — n-axis and p-axis — Properties

Designation			About n-axis and p-axis						Product of 2nd Moment of Area	Designation	
mm	mm	mm	$I_n=I_p$	$I_L=I_B$	$Z_{nB}=Z_{pL}$	$I_R=I_T$	$Z_{nT}=Z_{pR}$	$S_n=S_p$	$r_n=r_p$	I_{np}	
			10^6mm^4	mm	10^3mm^3	mm	10^3mm^3	10^3mm^3	mm	10^6mm^4	
200 x 200 x 26 EA			35.8	59.3	605	141	255	460	60.5	-20.9	200 x 200 x 26 EA
	20 EA		28.8	57.0	505	143	201	363	61.3	-16.9	20 EA
	18 EA		26.3	56.2	467	144	183	330	61.5	-15.5	18 EA
	16 EA		23.7	55.4	427	145	164	296	61.8	-14.0	16 EA
	13 EA		19.7	54.2	363	146	135	243	62.2	-11.6	13 EA
150 x 150 x 19 EA			11.1	44.2	250	106	105	189	45.4	-6.48	150 x 150 x 19 EA
	16 EA		9.48	43.0	220	107	88.7	160	45.8	-5.58	16 EA
	12 EA		7.46	41.5	180	108	68.8	124	46.3	-4.40	12 EA
	10 EA		6.04	40.5	149	109	55.2	99.9	46.6	-3.56	10 EA
125 x 125 x 16 EA			5.32	36.8	144	88.2	60.3	109	37.9	-3.11	125 x 125 x 16 EA
	12 EA		4.21	35.4	119	89.6	47.0	85.0	38.3	-2.48	12 EA
	10 EA		3.42	34.4	99.4	90.6	37.8	68.4	38.6	-2.02	10 EA
	8 EA		2.86	33.7	84.9	91.3	31.3	56.8	38.8	-1.69	8 EA
100 x 100 x 12 EA			2.08	29.2	71.1	70.8	29.3	53.2	30.3	-1.22	100 x 100 x 12 EA
	10 EA		1.70	28.2	60.1	71.8	23.6	42.9	30.6	-1.00	10 EA
	8 EA		1.42	27.5	51.7	72.5	19.6	35.7	30.8	-0.842	8 EA
	6 EA		1.12	26.8	41.8	73.2	15.3	27.8	31.0	-0.661	6 EA
90 x 90 x 10 EA			1.22	25.7	47.3	64.3	18.9	34.4	27.4	-0.716	90 x 90 x 10 EA
	8 EA		1.02	25.0	40.9	65.0	15.7	28.7	27.6	-0.604	8 EA
	6 EA		0.805	24.3	33.2	65.7	12.3	22.4	27.7	-0.475	6 EA
75 x 75 x 10 EA			0.681	22.0	31.0	53.0	12.8	23.4	22.6	-0.399	75 x 75 x 10 EA
	8 EA		0.575	21.3	27.0	53.7	10.7	19.6	22.7	-0.338	8 EA
	6 EA		0.455	20.5	22.1	54.5	8.35	15.3	22.9	-0.268	6 EA
	5 EA		0.355	19.9	17.9	55.1	6.44	11.8	23.0	-0.208	5 EA
65 x 65 x 10 EA			0.437	19.6	22.3	45.4	9.62	17.4	19.5	-0.254	65 x 65 x 10 EA
	8 EA		0.371	19.0	19.6	46.0	8.07	14.6	19.7	-0.218	8 EA
	6 EA		0.296	18.3	16.2	46.7	6.34	11.5	19.9	-0.175	6 EA
	5 EA		0.234	17.7	13.2	47.3	4.94	8.97	20.1	-0.138	5 EA
55 x 55 x 6 EA			0.175	15.8	11.1	39.2	4.46	8.11	16.7	-0.103	55 x 55 x 6 EA
	5 EA		0.139	15.2	9.12	39.8	3.48	6.34	16.8	-0.0814	5 EA
50 x 50 x 8 EA			0.160	15.2	10.5	34.8	4.61	8.38	14.9	-0.0928	50 x 50 x 8 EA
	6 EA		0.129	14.5	8.90	35.5	3.64	6.63	15.1	-0.0756	6 EA
	5 EA		0.103	13.9	7.36	36.1	2.85	5.19	15.2	-0.0602	5 EA
	3 EA		0.0694	13.2	5.25	36.8	1.89	3.46	15.3	-0.0405	3 EA
45 x 45 x 6 EA			0.0922	13.3	6.93	31.7	2.91	5.30	13.5	-0.0538	45 x 45 x 6 EA
	5 EA		0.0734	12.7	5.76	32.3	2.28	4.16	13.6	-0.0432	5 EA
	3 EA		0.0498	12.0	4.14	33.0	1.51	2.77	13.8	-0.0292	3 EA
40 x 40 x 6 EA			0.0631	12.0	5.24	28.0	2.26	4.12	11.9	-0.0366	40 x 40 x 6 EA
	5 EA		0.0505	11.5	4.39	28.5	1.77	3.24	12.0	-0.0296	5 EA
	3 EA		0.0344	10.8	3.19	29.2	1.18	2.17	12.2	-0.0201	3 EA
30 x 30 x 6 EA			0.0247	9.53	2.59	20.5	1.21	2.22	8.71	-0.0140	30 x 30 x 6 EA
	5 EA		0.0200	8.99	2.22	21.0	0.951	1.76	8.83	-0.0116	5 EA
	3 EA		0.0138	8.30	1.66	21.7	0.635	1.18	8.93	-0.00804	3 EA
25 x 25 x 6 EA			0.0135	8.28	1.63	16.7	0.807	1.49	7.13	-0.00750	25 x 25 x 6 EA
	5 EA		0.0110	7.75	1.42	17.3	0.638	1.19	7.23	-0.00632	5 EA
	3 EA		0.00765	7.07	1.08	17.9	0.426	0.802	7.33	-0.00446	3 EA

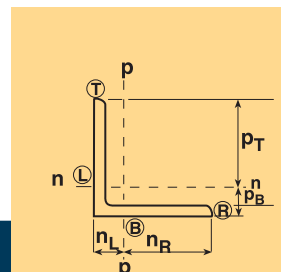
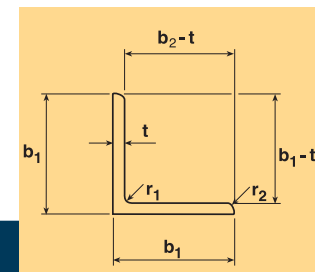

Unequal Angles

Table 28 Unequal Angles — x-axis and y-axis — Dimensions and Properties

Designation		Mass per Thick-ness	Actual Thick-ness	Radii		Gross Area of Section		Coordi-nate of Centroid		About x-axis										About y-axis					Torsion Constant	Tan Alpha	Designation					
Leg-size	Normal Thick-ness	m	t	Root	Toe	(b ₁ -t)	(b ₂ -t)	Cross Section	Centroid																J							
b ₁ x b ₂				r ₁	r ₂	t	t	A _g	p _B	n _L	I _x	y ₁	Z _{x1}	y ₄	Z _{x4}	y ₅	Z _{x5}	S _x	r _x	I _y	x ₂	Z _{y2}	x ₃	Z _{y3}	x ₅	Z _{y5}	S _y	r _y				
mm	mm	kg/m	mm	mm	mm	mm	mm	mm ²	mm	mm	10 ⁶ mm ⁴	mm	10 ³ mm ³	mm	10 ³ mm ³	mm	10 ³ mm ³	10 ³ mm ³	mm	10 ⁶ mm ⁴	mm	10 ³ mm ³	mm	10 ³ mm ³	mm	10 ³ mm ³	10 ³ mm ³	mm	10 ³ mm ⁴			
150 x 100 x 12 UA	10 UA	22.5	12.0	10.0	5.0	11.5	7.33	2870	49.1	24.3	7.51	102	73.5	75.3	99.7	35.2	213	127	51.2	1.35	27.6	48.8	52.9	25.5	42.0	32.1	51.7	21.7	141	0.438	150 x 100 x 12 UA	
		18.0	9.5	10.0	5.0	14.8	9.53	2300	48.1	23.3	6.11	103	59.5	74.9	81.5	34.6	177	102	51.6	1.09	26.9	40.7	53.0	20.6	40.7	26.9	41.8	21.8	71.9	0.441	10 UA	
150 x 90 x 16 UA	12 UA	27.9	15.8	10.0	5.0	8.49	4.70	3550	52.5	22.7	8.80	99.5	88.4	71.9	122	41.9	210	154	49.8	1.32	24.6	53.8	49.9	26.5	38.9	34.0	55.9	19.3	300	0.353	150 x 90 x 16 UA	
		21.6	12.0	10.0	5.0	11.5	6.50	2750	51.0	21.2	6.97	100	69.4	71.3	97.8	40.8	171	120	50.4	1.04	23.4	44.5	50.1	20.8	37.2	28.0	43.8	19.5	136	0.360	12 UA	
		17.3	9.5	10.0	5.0	14.8	8.47	2200	50.0	20.2	5.66	101	56.1	70.7	80.1	40.1	141	96.6	50.7	0.847	22.6	37.4	50.4	16.8	36.1	23.5	35.4	19.6	69.0	0.363	10 UA	
		14.3	7.8	10.0	5.0	18.2	10.5	1820	49.2	19.6	4.73	101	46.7	70.3	67.3	39.5	120	80.1	51.0	0.710	22.1	32.2	50.6	14.0	35.2	20.2	29.5	19.7	39.0	0.364	8 UA	
125 x 75 x 12 UA	10 UA	17.7	12.0	8.0	5.0	9.42	5.25	2260	43.3	18.4	3.91	83.2	47.0	59.7	65.5	34.6	113	81.4	41.6	0.585	19.9	29.3	41.4	14.1	31.9	18.4	29.7	16.1	110	0.356	125 x 75 x 12 UA	
		14.2	9.5	8.0	5.0	12.2	6.89	1810	42.3	17.5	3.20	83.8	38.2	59.3	53.9	33.9	94.4	65.8	42.0	0.476	19.2	24.9	41.6	11.4	30.7	15.5	24.1	16.2	56.2	0.360	10 UA	
		11.8	7.8	8.0	5.0	15.0	8.62	1500	41.5	16.8	2.68	84.2	31.8	58.9	45.5	33.3	80.4	54.6	42.2	0.399	18.6	21.5	41.8	9.55	29.9	13.3	20.1	16.3	31.7	0.363	8 UA	
		9.16	6.0	8.0	5.0	19.8	11.5	1170	40.7	16.0	2.10	84.7	24.8	58.5	36.0	32.8	64.1	42.4	42.5	0.315	18.0	17.5	42.1	7.47	29.0	10.8	15.7	16.4	14.8	0.364	6 UA	
100 x 75 x 10 UA	8 UA	12.4	9.5	8.0	5.0	9.53	6.89	1580	31.8	19.4	1.89	69.2	27.3	54.5	34.6	18.6	101	46.5	34.6	0.401	22.3	18.0	36.4	11.0	32.2	12.5	21.2	16.0	49.1	0.546	100 x 75 x 10 UA	
		10.3	7.8	8.0	5.0	11.8	8.62	1310	31.1	18.7	1.59	69.4	22.9	54.3	29.2	18.2	87.0	38.7	34.8	0.337	21.8	15.4	36.4	9.26	31.3	10.7	17.8	16.0	27.8	0.549	8 UA	
		7.98	6.0	8.0	5.0	15.7	11.5	1020	30.3	17.9	1.25	69.7	17.9	54.0	23.1	17.9	70.0	30.1	35.1	0.265	21.4	12.4	36.5	7.27	30.3	8.75	13.9	16.2	13.0	0.551	6 UA	
75 x 50 x 8 UA	6 UA	7.23	7.8	7.0	3.0	8.62	5.41	921	25.2	12.8	0.586	50.8	11.5	37.8	15.5	18.0	32.5	20.0	25.2	0.106	14.2	7.46	26.4	4.01	21.7	4.88	8.19	10.7	19.5	0.430	75 x 50 x 8 UA	
		5.66	6.0	7.0	3.0	11.5	7.33	721	24.4	12.1	0.468	51.2	9.15	37.5	12.5	17.6	26.7	15.8	25.5	0.0842	13.6	6.17	26.5	3.18	20.8	4.04	6.48	10.8	9.21	0.435	6 UA	
		4.40	4.6	7.0	3.0	15.3	9.87	560	23.8	11.5	0.370	51.5	7.17	37.2	9.93	17.2	21.5	12.3	25.7	0.0666	13.2	5.03	26.6	2.50	20.1	3.32	5.09	10.9	4.32	0.437	5 UA	
65 x 50 x 8 UA	6 UA	6.59	7.8	6.0	3.0	7.33	5.41	840	21.1	13.6	0.421	44.9	9.37	36.3	11.6	11.6	36.4	16.1	22.4	0.0936	15.6	6.00	23.9	3.91	22.3	4.20	7.49	10.6	17.6	0.570	65 x 50 x 8 UA	
		5.16	6.0	6.0	3.0	9.83	7.33	658	20.4	12.9	0.338	45.2	7.48	36.1	9.35	11.2	30.2	12.7	22.7	0.0743	15.1	4.91	23.9	3.11	21.4	3.48	5.93	10.6	8.29	0.575	6 UA	
		4.02	4.6	6.0	3.0	13.1	9.87	512	19.8	12.4	0.267	45.4	5.89	35.9	7.43	10.9	24.5	9.92	22.8	0.0587	14.8	3.97	23.9	2.46	20.6	2.85	4.66	10.7	3.87	0.577	5 UA	

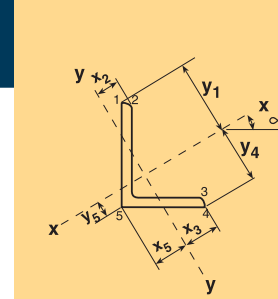
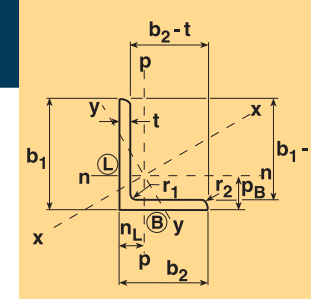

Unequal Angles

Table 29 Unequal Angles — x-axis and y-axis — Properties for Assessing Section Capacity

Designation			Yield Stress	Form Factor	About x-axis		About y-axis		Yield Stress	Form Factor	About x-axis		About y-axis		Designation	
mm	mm	mm			MPa	MPa	Load A	Load C			Load B	Load D	MPa	MPa		Load A
			f_y	k_f	Z_{ex}	Z_{ex}	Z_{ey}	Z_{ey}	f_y	k_f	Z_{ex}	Z_{ex}	Z_{ey}	Z_{ey}		
					10^3mm^3	10^3mm^3	10^3mm^3	10^3mm^3			10^3mm^3	10^3mm^3	10^3mm^3	10^3mm^3		
					300PLUS*				AS/NZS 3679.1-350							
150 x 100 x 12 UA	300	1.00	102	110	35.3	38.2	340	1.00	100	110	34.7	38.2	150 x 100 x 12 UA			
10 UA	320	0.975	74.8	81.7	26.0	30.9	360	0.943	73.0	78.9	25.3	30.9	10 UA			
150 x 90 x 16 UA	300	1.00	132	133	39.5	39.8	340	1.00	130	133	39.0	39.8	150 x 90 x 16 UA			
12 UA	300	1.00	96.3	104	28.8	31.1	340	1.00	94.6	104	28.3	31.1	12 UA			
10 UA	320	0.973	70.6	81.8	21.2	25.2	360	0.940	68.8	79.5	20.6	25.2	10 UA			
8 UA	320	0.863	53.1	60.3	15.9	21.0	360	0.836	51.2	57.9	15.4	21.0	8 UA			
125x 75 x 12 UA	300	1.00	68.6	70.5	20.6	21.2	340	1.00	67.6	70.5	20.3	21.2	125x 75 x 12 UA			
10 UA	320	1.00	51.6	57.2	15.5	17.2	360	1.00	50.6	57.2	15.2	17.2	10 UA			
8 UA	320	0.964	39.8	46.0	11.9	14.3	360	0.931	38.8	44.7	11.6	14.3	8 UA			
6 UA	320	0.824	26.8	30.1	8.07	11.2	360	0.799	25.8	28.7	7.75	11.2	6 UA			
100 x 75 x 10 UA	320	1.00	39.4	40.9	15.9	16.6	360	1.00	38.8	40.9	15.7	16.6	100 x 75 x 10 UA			
8 UA	320	1.00	31.2	33.1	12.6	13.9	360	1.00	30.6	32.1	12.4	13.9	8 UA			
6 UA	320	0.946	22.0	21.8	8.93	10.9	360	0.917	21.4	20.7	8.68	10.9	6 UA			
75 x 50 x 8 UA	320	1.00	17.0	17.3	5.93	6.02	360	1.00	16.8	17.3	5.85	6.02	75 x 50 x 8 UA			
6 UA	320	1.00	12.6	13.7	4.37	4.77	360	1.00	12.4	13.7	4.30	4.77	6 UA			
5 UA	320	0.956	8.89	9.65	3.10	3.75	360	0.926	8.66	9.30	3.02	3.75	5 UA			
65 x 50 x 8 UA	320	1.00	14.1	14.1	5.86	5.86	360	1.00	14.1	14.1	5.86	5.86	65 x 50 x 8 UA			
6 UA	320	1.00	10.7	11.2	4.46	4.67	360	1.00	10.6	11.2	4.40	4.67	6 UA			
5 UA	320	1.00	7.76	7.92	3.23	3.68	360	1.00	7.59	7.64	3.17	3.68	5 UA			

* 300PLUS replaced Grade 250 as the base grade for 150x90x8 unequal angles and larger in 1994.
 300PLUS replaced Grade 250 as the base grade for 125x75x12 unequal angles and smaller in 1997.
 300PLUS hot rolled sections are produced to exceed the minimum requirements of AS/NZS 3679.1-300.

Notes

1. For 300PLUS sections the tensile strength (f_u) is 440 MPa.
2. For Grade 350 sections the tensile strength (f_u) is 480 MPa.

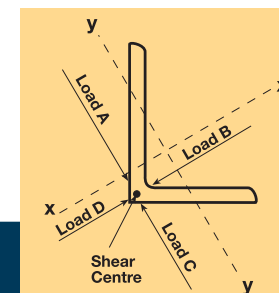

Unequal Angles

Table 30 Unequal Angles — n-axis and p-axis — Properties

Designation	About n-axis							About p-axis							Product of 2nd Moment of Area	Designation
	I_n	ρ_B	Z_{nB}	ρ_T	Z_{nT}	S_n	r_n	I_p	n_L	Z_{pL}	n_R	Z_{pR}	S_p	r_p		
mm mm mm	10^6mm^4	mm	10^3mm^3	mm	10^3mm^3	10^3mm^3	mm	10^6mm^4	mm	10^3mm^3	mm	10^3mm^3	10^3mm^3	mm	10^6mm^4	
150 x 100 x 12 UA	6.52	49.1	133	101	64.6	117	47.7	2.34	24.3	96.2	75.7	30.9	56.0	28.6	-2.27	150 x 100 x 12 UA
10 UA	5.29	48.1	110	102	51.9	94.0	48.0	1.91	23.3	81.9	76.7	24.9	44.7	28.8	-1.85	10 UA
150 x 90 x 16 UA	7.97	52.5	152	97.5	81.7	145	47.4	2.15	22.7	94.9	67.3	32.0	59.5	24.6	-2.35	150 x 90 x 16 UA
12 UA	6.29	51.0	123	99.0	63.5	114	47.8	1.72	21.2	81.0	68.8	25.0	45.7	25.0	-1.89	12 UA
10 UA	5.10	50.0	102	100	51.0	91.5	48.2	1.41	20.2	69.5	69.8	20.2	36.5	25.3	-1.54	10 UA
8 UA	4.26	49.2	86.6	101	42.3	76.0	48.4	1.18	19.6	60.4	70.4	16.8	30.1	25.5	-1.29	8 UA
125 x 75 x 12 UA	3.54	43.3	81.8	81.7	43.3	77.3	39.6	0.958	18.4	52.0	56.6	16.9	31.4	20.6	-1.05	125 x 75 x 12 UA
10 UA	2.88	42.3	68.2	82.7	34.9	62.5	39.9	0.789	17.5	45.2	57.5	13.7	25.1	20.9	-0.867	10 UA
8 UA	2.41	41.5	58.1	83.5	28.9	52.0	40.1	0.664	16.8	39.6	58.2	11.4	20.7	21.0	-0.731	8 UA
6 UA	1.89	40.7	46.5	84.3	22.5	40.6	40.3	0.524	16.0	32.7	59.0	8.89	16.0	21.2	-0.575	6 UA
100 x 75 x 10 UA	1.55	31.8	48.6	68.2	22.6	41.3	31.3	0.743	19.4	38.3	55.6	13.4	24.3	21.7	-0.625	100 x 75 x 10 UA
8 UA	1.30	31.1	41.8	68.9	18.8	34.4	31.5	0.626	18.7	33.5	56.3	11.1	20.2	21.9	-0.528	8 UA
6 UA	1.02	30.3	33.7	69.7	14.6	26.9	31.7	0.494	17.9	27.5	57.1	8.67	15.7	22.0	-0.416	6 UA
75 x 50 x 8 UA	0.511	25.2	20.3	49.8	10.3	18.5	23.6	0.181	12.8	14.1	37.2	4.86	8.96	14.0	-0.174	75 x 50 x 8 UA
6 UA	0.407	24.4	16.7	50.6	8.05	14.6	23.8	0.145	12.1	12.0	37.9	3.84	6.98	14.2	-0.140	6 UA
5 UA	0.321	23.8	13.5	51.2	6.27	11.4	23.9	0.115	11.5	10.0	38.5	3.00	5.41	14.3	-0.111	5 UA
65 x 50 x 8 UA	0.341	21.1	16.2	43.9	7.75	14.1	20.1	0.174	13.6	12.7	36.4	4.78	8.74	14.4	-0.141	65 x 50 x 8 UA
6 UA	0.272	20.4	13.4	44.6	6.10	11.1	20.3	0.140	12.9	10.8	37.1	3.77	6.85	14.6	-0.114	6 UA
5 UA	0.215	19.8	10.9	45.2	4.75	8.70	20.5	0.111	12.4	8.96	37.6	2.95	5.32	14.7	-0.0903	5 UA

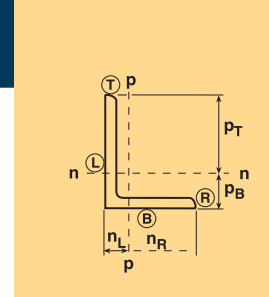
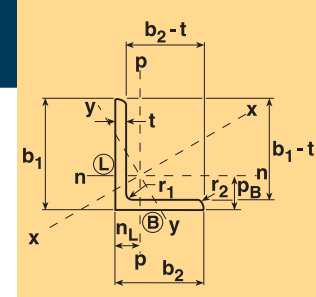

Rails

Table 31 Rails — Dimensions and Properties

Designation	Mass	a	b	c	d	e	f	g	r ₁	r ₂	r ₃	r ₄	S	t	x	y	Total Area	Head Area	Web Area	Foot Area	About x-axis			Designation
																					I _x	Head Z _x	Foot Z _x	
	kg/m	mm	mm	mm	mm	mm	mm	mm	mm	mm	mm	mm	mm	mm	mm	mm	mm ²	mm ²	mm ²	mm ²	10 ⁶ mm ⁴	10 ³ mm ³	10 ³ mm ³	
AS 68	67.5	74.6	185.7	49.2	106.4	30.2	152.4	78.6	19.1	14.3	254	19.1	40	17.5	4	85.0	8602	3125	2335	3142	39.4	391.7	463.8	AS 68
AS 60	60.7	70.0	170.0	49.0	93.0	28.0	146.0	74.5	20.0	15.0	300	20.0	20	16.5	4	79.1	7728	3018	1958	2752	29.4	323.2	371.4	AS 60
AS 50	50.7	70.0	154.0	45.0	84.0	25.0	127.0	67.0	15.0	15.0	300	15.0	20	15.0	4	74.8	6457	2729	1565	2164	20.2	254.1	269.3	AS 50
AS 41	40.8	63.5	136.5	40.5	74.6	21.4	127.0	60.3	9.5	11.0	305	9.5	∞	13.1	5	64.7	5192	2162	1122	1908	13.27	184.4	204.5	AS 41
OneSteel 53	53.1	70.0	157.1	46.0	86.5	24.6	146.0	67.9	9.5	11.0	305	12.7	∞	14.7	5	73.0	6763	2721	1520	2522	22.8	271.7	313.0	OneSteel 53

Notes: Some dimensions have been omitted for clarity, refer to AS 1085.1-2002 for additional dimensions

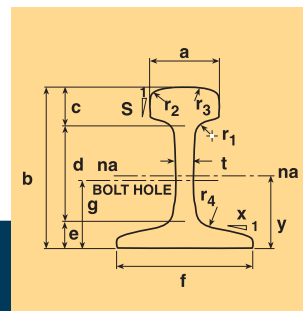

Structural Steel Sections

Structural Steel — Welded Sections — Standard: AS/NZS 3679.2:1996

Table 32 Chemical Composition — Welded Sections Base Plate

Grade (1)	Cast or Product Analysis, Percent														Micro-alloying Elements Max.	CE (4) Max.
	C		Si	Mn		P	S	Cr (2)		Ni (2)		Cu (2)		Mo (2)		
AS/NZS 3678	Max.	Min.	Max.	Max.	Max.	Max.	Min.	Max.	Max.	Min.	Max.	Max.	Max.	Max.	Max.	Max.
300 & 300 L15	0.22	*	0.55	1.70	0.040	0.030	*	0.30	0.50	*	0.40	0.10	0.100	0.040	(see Note 5)	0.44
400 & 400L15	0.22	*	0.55	1.70	0.040	0.030	*	0.30	0.50	*	0.40	0.35	0.100	0.040	(see Note 6)	0.48

* = No specified limit.

Notes

- The use of sulphide modification steelmaking techniques for listed grades is permitted.
- Cr + Ni + Cu + Mo = 1.00% maximum apply.
- Limits specified are for both acid soluble and total aluminium.
- Carbon equivalent (CE) is calculated from the equation based on actual cast or product analysis:

$$CE = C + \frac{Mn}{6} + \frac{Cr}{5} + \frac{Mo}{5} + \frac{V}{15} + \frac{Ni}{15} + Cu$$
- Niobium plus vanadium: 0.030% maximum.
- Vanadium: 0.10% maximum. Niobium plus vanadium plus titanium: 0.15% maximum.

Table 33 Tensile Properties — Welded Sections Base Plate

Property	Grade - AS/NZS 3678	
	300, 300L15	400, 400L15
Minimum Yield Strength — MPa for thickness of:		
> 8 ≤ 12	310	400
> 12 ≤ 20	300	380
> 20 ≤ 50	280	360
Minimum Tensile Strength — MPa	430	480
Minimum Elongation % of Gauge Length of 5.65√S ₀	21	18

Note

- S₀ is the cross-sectional area of the test piece before testing.

Table 34 Charpy V-Notch Impact Test Requirements — Welded Sections Base Plate

Grade	Test Temperature °C	Minimum Absorbed Energy, J Size of Test Piece					
		10 mm x 10 mm		10 mm x 7.5 mm		10 mm x 5 mm	
		Average of 3 Tests	Individual Test	Average of 3 Tests	Individual Test	Average of 3 Tests	Individual Test
AS/NZS 3678							
300L15	-15	27	20	22	16	18	13
400L15	-15	27	20	22	16	18	13

Structural Steel — Hot Rolled Bars and Sections — Standard: AS/NZ 3679.1:1996

Table 35 Chemical Composition — Bars and Sections

Grade (see Note 1)	Cast analysis (max.) (See Notes 2 and 3)						
	%						
	C	Si	Mn	P	S	Micro-alloying elements (see Note 4)	CE (see Note 5)
300PLUS®, 300PLUSLO	0.25	0.50	1.60	0.040	0.040	(see Note 6)	0.44
350, 350LO	0.22	0.50	1.60	0.040	0.040	(see Note 7)	0.45

Notes

- The use of sulfide modification steel making techniques for these grades is permitted.
- Grain refining elements, ie aluminium and titanium, may be added, provided that the total content does not exceed 0.15%. Limits are for total or soluble aluminium.
- The following elements may be present to the limits stated, subject to a maximum total of 1.00%:
 - Copper 0.50%
 - Nickel 0.50%
 - Chromium 0.30%
 - Molybdenum 0.10%
- For grade 300PLUS, the following are not considered as micro-alloying elements:
 - Titanium 0.040% maximum
 - Niobium 0.020% maximum
 - Vanadium 0.030% maximum
 - Niobium plus vanadium 0.030% maximum

- Carbon equivalent (CE) is calculated from the following equation:

$$CE = C + \frac{Mn}{6} + \frac{Cr + Mo + V}{5} + \frac{Ni + Cu}{15}$$

- Micro-alloying elements are not permitted in grade 300 except for thicknesses greater than or equal to 15mm, where the following apply:
 - the maximum combined micro-alloying element content is 0.15%
 - where micro-alloying elements are used, the percentage of each element is to be shown on the certificates.
- For grade 350, micro-alloying elements niobium, vanadium and titanium may be added, provided that their total combined content does not exceed 0.15%.

Table 36 Tensile Properties — Flat Bars and Sections

Grade	Minimum yield stress, MPa				Minimum tensile strength	Minimum elongation on a gauge length of $5.65 \sqrt{S_0}$ (see Note 2)
	Thickness, mm (see Note 1)					
	<11	≥11 to ≤17	>17 to <40	≥40	MPa	%
300PLUS®, 300PLUSLO	320	300	280	280	440	22
350	360	340	340	330	480	20

Table 37 Tensile Properties — Round, Hexagonal and Square Bars

Grade	Minimum yield stress, MPa			Minimum tensile strength	Minimum elongation on a gauge length of $5.65 \sqrt{S_0}$
	Thickness, mm				
	≤50	>50 to <100	≥100	MPa	%
300PLUS®	300	290	280	440	22
350	340	330	320	480	20

Notes (apply to tables 36 and 37)

- For a section, the term 'thickness' refers to the nominal thickness of the part from which the sample is taken.
- S_0 is the cross-sectional area of the test piece before testing.
- For precise details of properties reference should be made to the latest edition of AS/NZS 3679.1:1996 or the latest OneSteel specification.
- 300PLUS® steel is produced to exceed the latest requirements for grade 300 in AS/NZS 3679.1.

Table 37a Charpy V-Notch Impact Test Requirements — Bars and Sections

Grade	Test Temperature °C	Minimum Absorbed Energy, J Size of Test Piece					
		10 mm x 10 mm		10 mm x 7.5 mm		10 mm x 5 mm	
		Average of 3 Tests	Individual Test	Average of 3 Tests	Individual Test	Average of 3 Tests	Individual Test
300PLUSLO, 350LO	0	27	20	22	16	18	13

Notes: This does not cover impact tested grades for thickness less than 8 mm.

Rail Products

Table 38 Chemical Composition (ladle analysis)

Designation	Standard	Elements %				
		Carbon	Silicon	Manganese	Phosphorus	Sulphur
AS 41	AS 1085.1-2002	0.53-0.69	0.15-0.58	0.60-0.95	0.025 max.	0.025 max.
AS 50	AS 1085.1-2002	0.65-0.82	0.15-0.58	0.70-1.25	0.025 max.	0.025 max.
AS 60	AS 1085.1-2002	0.65-0.82	0.15-0.58	0.70-1.25	0.025 max.	0.025 max.
AS 68	AS 1085.1-2002	0.65-0.82	0.15-0.58	0.70-1.25	0.025 max.	0.025 max.
OneSteel 53	OneSteel	0.65-0.82	0.10-0.58	0.70-1.25	0.025 max.	0.025 max.

Note:

1. All rails are manufactured from fully killed continuously cast steel.

Table 39 Minimum Mechanical Properties — Rails

Designation	Type	0.2% Proof Stress MPa	Tensile Strength MPa	% Elongation Gauge Length = 5.65 $\sqrt{S_0}$	Surface Hardness HB
AS 41	As Rolled Rail	-	700	8	-
AS 50	As Rolled Rail	420	880	8	260
AS 60	As Rolled Rail	420	880	8	260
AS 68	As Rolled Rail	420	880	8	260
OneSteel 53	As Rolled Rail	420	880	8	260
AS 50 kg HH	Head Hardened Rail	780	1130	9	340
AS 60 kg HH	Head Hardened Rail	780	1130	9	340
AS 68 kg HH	Head Hardened Rail	780	1130	9	340

Merchant Bar Sections

Table 40 Chemical Composition — For OneSteel Merchant Bar Sections — Regular Grades — AS 1442

Steel Type	Grade	C		Si		Mn		P		S	
		Min.	Max.	Min.	Max.	Min.	Max.	Min.	Max.	Min.	Max.
Carbon and Carbon	U1008	*	0.10	*	0.35	0.25	0.50	*	0.040	*	0.040
Manganese Steels	U1010	0.08	0.13	*	0.35	0.30	0.60	*	0.040	*	0.040
	1016	0.13	0.18	0.10	0.35	0.60	0.90	*	0.040	*	0.040
	U1021	0.18	0.23	*	0.35	0.60	0.90	*	0.040	*	0.040
	1022	0.18	0.23	0.10	0.35	0.70	1.00	*	0.040	*	0.040
	1030	0.28	0.34	0.10	0.35	0.60	0.90	*	0.040	*	0.040
	X1038	0.35	0.42	0.10	0.35	0.70	1.00	*	0.040	*	0.040
	1040	0.37	0.44	0.10	0.35	0.60	0.90	*	0.040	*	0.040
	U1040	0.37	0.44	*	0.35	0.60	0.90	*	0.040	*	0.040
	1045	0.43	0.50	0.10	0.35	0.60	0.90	*	0.040	*	0.040
	U1045	0.43	0.50	*	0.35	0.60	0.90	*	0.040	*	0.040
	1055	0.50	0.60	0.10	0.35	0.60	0.90	*	0.040	*	0.040
	1070	0.65	0.75	0.10	0.35	0.60	0.90	*	0.040	*	0.040
	U1070	0.65	0.75	*	0.35	0.60	0.90	*	0.040	*	0.040
Mechanically Tested	X1320	0.18	0.23	0.10	0.35	1.40	1.70	*	0.040	*	0.040
	X1340	0.38	0.43	0.10	0.35	1.40	1.70	*	0.040	*	0.040
	10M40 ⁽¹⁾	0.37	0.44	0.10	0.35	0.60	0.90	*	0.040	*	0.040
	U3	*	0.25	*	0.40	*	1.40	*	0.040	*	0.040
Merchant Quality Steels	U5	0.35	0.45	*	0.40	0.50	1.00	*	0.040	*	0.040
	U6	0.40	0.50	*	0.40	0.50	1.00	*	0.040	*	0.040
	9	0.15	0.25	0.10	0.40	1.30	1.70	*	0.040	*	0.040
Free Cutting Steels	M1020	0.15	0.25	*	0.35	0.30	0.90	*	0.050	*	0.050
	M1030	0.25	0.35	*	0.35	0.30	0.90	*	0.050	*	0.050
Free Cutting Steels	1137	0.32	0.39	0.10	0.35	1.35	1.65	*	0.040	0.08	0.13
	1146	0.42	0.49	0.10	0.35	0.70	1.00	*	0.040	0.08	0.13
	X1147	0.40	0.47	0.10	0.35	1.60	1.90	*	0.040	0.07	0.12
	1214	*	0.15	*	0.10	0.80	1.20	0.040	0.090	0.25	0.35

Note:

1. This grade is treated with the micro-alloying element vanadium.

Merchant Bar Sections (continued)

Table 41 Tensile Properties — Hot Rolled Bar Sections — Regular Grades — AS 1442

Designation	Form	Specified Size mm	Min. Yield Strength MPa	Min. Tensile Strength MPa	Min. % Elongation Gauge Length = $5.65 \sqrt{S_0}$
U3	Rounds, Squares, Hexagons	≤50	250	410	22
		> 50≤170	230	410	22
	Flat Bar	≤12	260	410	22
		>12≤40	250	410	22
		>40≤60	230	410	22
	Billets	≤120	230	410	22
U5	Bars	≤100	270	540	16
U6	Bars	≤100	300	600	14
9	Bars & Billets	≤100	300	540	18

Table 42 Chemical Composition — For OneSteel Merchant Bar Sections — Regular Grades — AS 1444 & AS 1447

Steel Type	Grade	C		Si		Mn		P		S		Cr	
		Min.	Max.	Min.	Max.	Min.	Max.	Min.	Max.	Min.	Max.	Min.	Max.
Alloy Steels and Spring Steels	5155	0.50	0.60	0.10	0.35	0.70	1.00	*	0.040	*	0.040	0.70	0.90
	5160	0.55	0.65	0.10	0.35	0.70	1.00	*	0.040	*	0.040	0.70	0.90
	9255	0.50	0.60	1.60	2.20	0.70	1.05	*	0.040	*	0.040	*	*
	9258	0.55	0.65	1.60	2.20	0.70	1.05	*	0.040	*	0.040	*	*
	9261	0.55	0.65	1.80	2.20	0.70	1.00	*	0.040	*	0.040	0.10	0.25

Notes

- Merchant Bar Sections are also available in AS/NZS 3679.1:1996 specification. See Tables 35 to 37. Other grades may be available on enquiry.

Table 43 OneSteel Grades

Steel Type	Grade	C		Si		Mn		P		S		Cr		V	
		Min.	Max.	Min.	Max.	Min.	Max.	Min.	Max.	Min.	Max.	Min.	Max.	Min.	Max.
OneSteel	U1004	*	0.06	*	0.05	0.25	0.50	*	0.040	*	0.050	*	*	*	*
	1015	0.13	0.18	0.10	0.35	0.30	0.60	*	0.040	*	0.050	*	*	*	*
	1082	0.78	0.90	0.10	0.35	0.60	0.90	*	0.050	*	0.050	*	*	*	*
	X4K92M61S	0.55	0.65	1.60	1.90	0.70	1.00	*	0.040	*	0.040	0.10	0.25	0.15	0.25

Table 44 Heat Treatment Limitations

Grade	Maximum Recommended Cross Section*		
	Rounds	Squares	Flats
5155	32 mm	30 mm	22 mm
5160	40 mm	36 mm	28 mm
9261	27 mm	25 mm	19 mm
9255	28 mm	25 mm	
9258		16 mm	

*The recommendations are based on the criterion that, at the maximum dimensions, a hardness of 50 HRC can be achieved in the centre of the quenched section.

The actual properties obtained are dependent on both grade and heat treatment process control. As OneSteel has no control over the springmakers' heat treatment process, the above recommendations cannot be guaranteed. However, springmakers with efficient heat treatment facilities will be able to achieve a hardness value of 50 HRC as recommended.

OneSteel Direct - free call 1800 1 78335

All customer service enquiries for OneSteel Market Mills products described in this publication should be directed to the OneSteel Direct free call service on 1800 1 STEEL (1800 1 78335).

OneSteel Direct provides a 'one stop shop' service for customers and users of steel requiring information on OneSteel Market Mills and its products. It is staffed by a centralised team of experienced personnel specialising in Technical, Sales, Marketing and Public Affairs knowledge.

OneSteel Direct's services include the following:

- Product and application technical support incorporating a network of expert OneSteel metallurgists, engineers and scientists located throughout Australia.
- Fast brochure and technical information mailout and facsimile services.
- Immediate referral service to approved OneSteel Market Mills distributors and service providers in your area.

OneSteel Direct's services are available Mon-Fri from 8.00am to 6.00pm (AEST)

- Freecall 1800 1 STEEL (1800 1 78335)
- Freefax 1800 101 141
- E-mail onesteeldirect@onesteel.com
- Mailing Address Locked Bag 8825
South Coast Mail Centre
NSW 2521
- International Telephone +61 2 4222 3456
- International Facsimile +61 2 4222 3434



This publication has been prepared by OneSteel Market Mills an operating business group of which OneSteel Manufacturing Pty Limited ABN 42 004 651 325 is a part. Please note that any specifications or technical data referred to in this publication are subject to change and/or variation or improvement without notice and no warranty as to their suitability for any use is made. Users of this publication – to ensure accuracy and adequacy for their purposes – are requested to check the information provided in this publication to satisfy themselves as to its appropriateness and not to rely on the information without first doing so. Unless required by law, the company cannot accept any responsibility for any loss, damage or consequence resulting from the use of this publication. Photographs shown are representative only of typical applications, current at Dec 2003. This brochure is not an offer to trade and shall not form any part of the trading terms in any transaction. ©Copyright 2003. OneSteel Manufacturing Pty Limited ABN 42 004 651 325 Registered Trademarks of OneSteel Manufacturing Pty Limited ABN 42 004 651 325: 300PLUS®; 3rd Edition. Dec 2003 BC0031

Head Office**OneSteel Market Mills**

PO Box 245C
Newcastle NSW 2300
Telephone: (02) 4935 5555
Facsimile: (02) 4935 5490

OneSteel Market Mills Sales Offices**New South Wales**

Cnr Milperra & Mons Roads, Revesby NSW 2212
PO Box 4664, Milperra NSW 1891
Tel: (02) 9792 9092 Fax: (02) 9792 9093

Queensland

220 Bradman Street, Acacia Ridge QLD 4110
PO Box 300, Acacia Ridge QLD 4110
Tel: (07) 3845 5606 Fax: (07) 3845 5609

South Australia & Northern Territory

519 Cross Keys Road, Cavan SA 5094
PO Box 21, Dry Creek SA 5094
Tel: (08) 8260 9350 Fax: (08) 8260 9355

Victoria & Tasmania

83 Westgate Drive, Altona North VIC 3025
PO Box 150, Altona North VIC 3025
Tel: (03) 9931 2600 Fax: (03) 9931 2650

Western Australia

310 Selby Street North, Osborne Park WA 6017
PO Box 1418, Osborne Park WA 6916
Tel: (08) 6332 3131 Fax: (08) 6332 3132

New Zealand

Building 5, Level 1
666 Great South Road, Central Park
Penrose, Auckland NZ
PO Box 62 - 574, Central Park
Penrose, Auckland NZ
Tel: (09) 579 1500 Fax: (09) 579 1555

Rail Sales & Marketing Office**OneSteel Whyalla Steelworks**

38 Heath Street, Lonsdale SA 5160
PO Box 951. Morphett Vale SA 5162
Tel: (08) 8326 7400 Fax: (08) 8326 3461

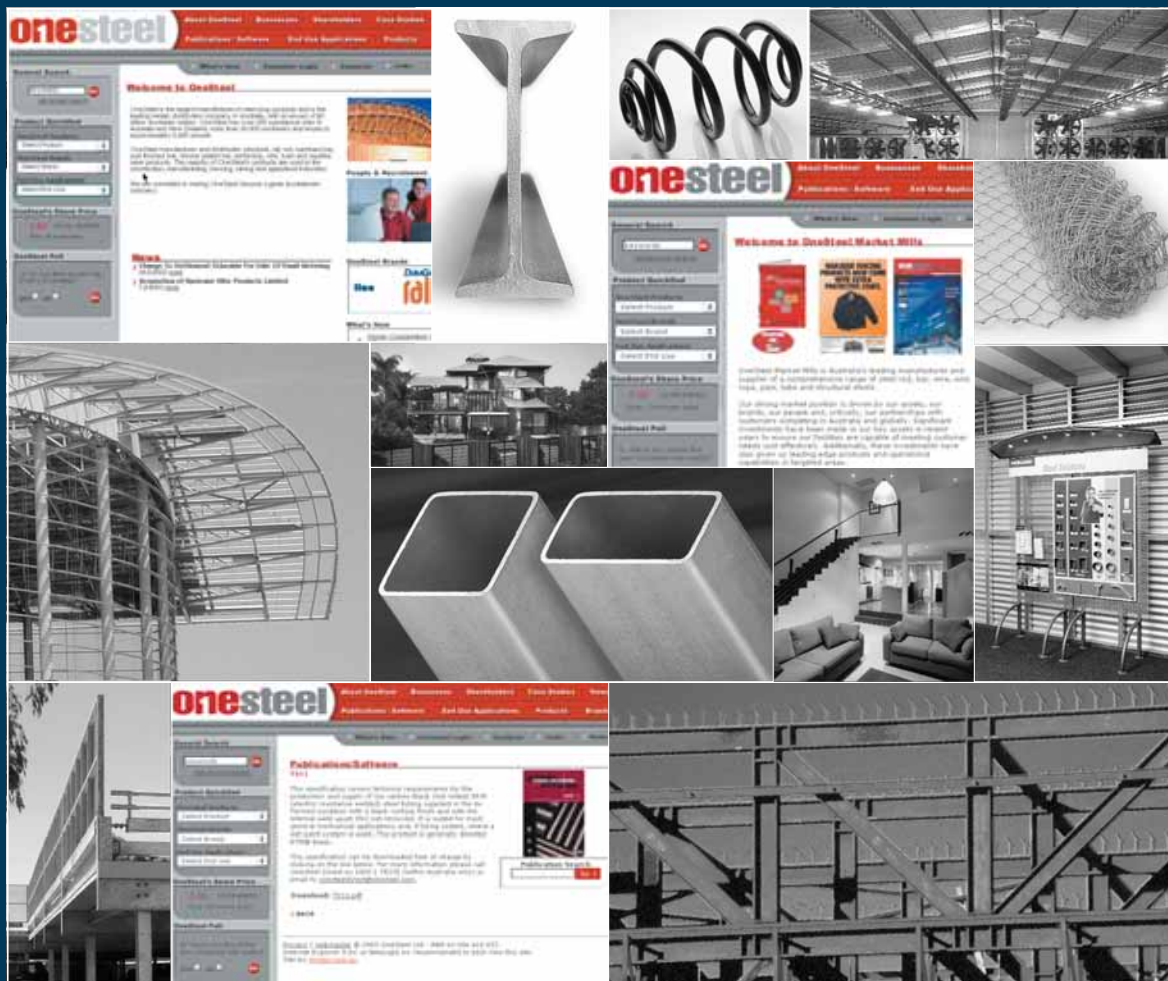

One website, 1001 specifications.

OneSteel is dedicated to the manufacture of Australia's leading steel long products.

If you need to know product specifications, conversions, links to international standards, and just about any technical question to do with the incredible range of OneSteel Australian made products then check our website.

Structural steel, pipe and tube, rails, reinforcing steel, rod, bar and wire are just part of the incredible range of products we manufacture.

When you visit our website, find the product you require information for under the "Products" drop menu.

Once you have selected the product then click the "Publications and Tools" tab that appears to the right of the product listings.

This will allow you to download and print out all the technical specifications you need to know about our products plus other helpful information.

You do not need to be a OneSteel customer to access this information. It is there to help make the life of metallurgists and engineers a bit easier when finding data to make your calculations and appraisals of products.

Take a look at our website or feel free to call or email to find out more information and how OneSteel can help your company.

onesteel
market mills

CALL 1800 178 335 WEBSITE www.onesteel.com EMAIL onesteeldirect@onesteel.com

NOTES

onesteel

market mills

OneSteel publications and product literature are available
by contacting OneSteel Direct.

ONESTEEL DIRECT

Freecall: 1800 1 STEEL (1800 1 78335)

Freefax: 1800 101 141

Web: www.onesteel.com

Email: onesteeldirect@onesteel.com

39-45 Flagstaff Road, Port Kembla, NSW 2505

Postal: Locked Bag 8825, South Coast Mail Centre,
NSW 2521 Australia

Distributed By

This publication has been prepared by OneSteel Market Mills an operating business group of which OneSteel Manufacturing Pty Limited ABN 42 004 651 325 is a part. Please note that any specifications or technical data referred to in this publication are subject to change and/or variation or improvement without notice and no warranty as to their suitability for any use is made. Users of this publication – to ensure accuracy and adequacy for their purposes – are requested to check the information provided in this publication to satisfy themselves as to its appropriateness and not to rely on the information without first doing so. Unless required by law, the company cannot accept any responsibility for any loss, damage or consequence resulting from the use of this publication. Photographs shown are representative only of typical applications, current at Dec 2003. This brochure is not an offer to trade and shall not form any part of the trading terms in any transaction.

©Copyright 2003. OneSteel Manufacturing Pty Limited ABN 42 004 651 325
Registered Trademarks of OneSteel Manufacturing Pty Limited ABN 42 004 651 325: 300PLUS®
Issue 3. Printed December 2003 BC0031

